

# Tall Hood-type Series Operation/Cleaning Guide

# OPERATION

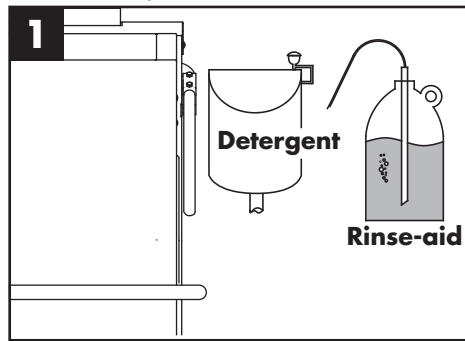

Check chemical levels in containers.

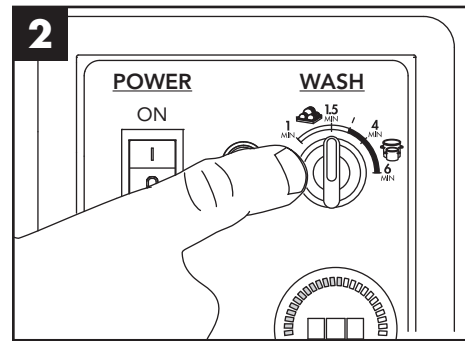

Close hood & select wash time (1, 1.5, 4 or 6 min. ).

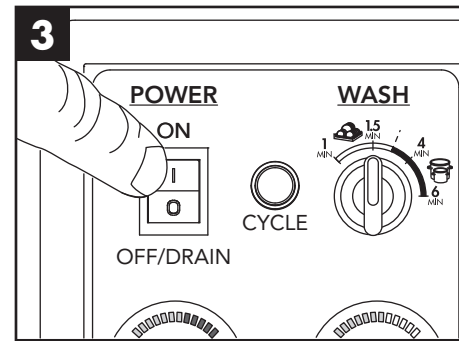

Press power switch to ON position, machine fills.

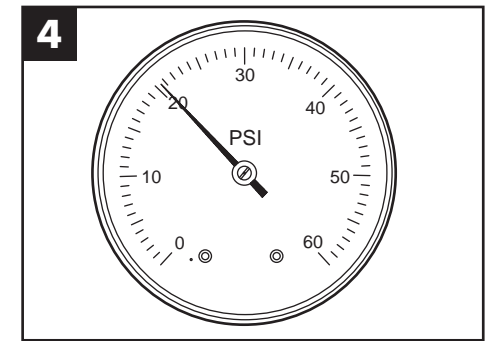

Check pressure gauge & make sure reading is 20-22 PSI.

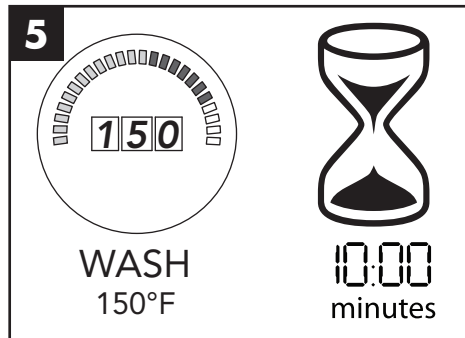

Wait 10 minutes for the display to indicate 150°F/66°C.

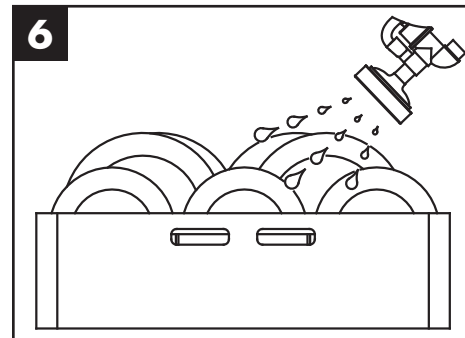

Prescrap & load wares into dish racks. Wash one rack at a time.

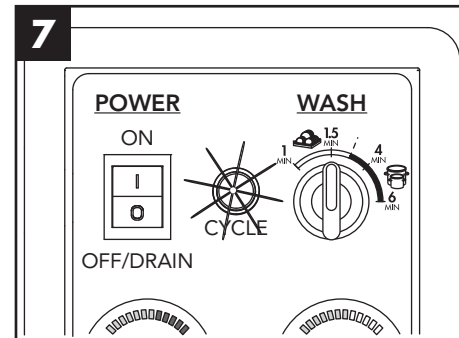

Load the dish rack & close the hood. The green cycle light illuminates & the timed cycle starts automatically.

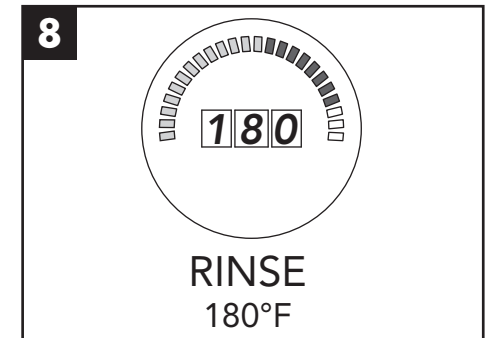

The final rinse water temperature display must indicate a minimum of 180°F/82°C during the final rinse.

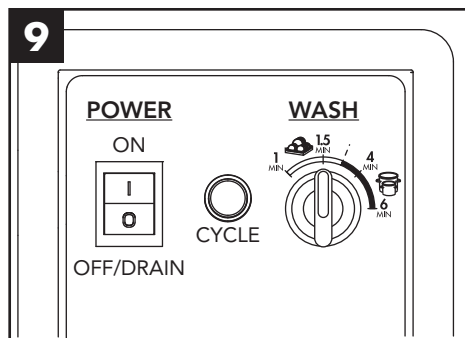

When the green cycle light goes out, remove the dish rack of clean wares.

**AUTOMATIC DRAIN CYCLE** →

The dishwasher can be drained automatically at the end of normal wash cycle or whenever the dishwasher is idle.

**TO DRAIN THE DISHWASHER** →

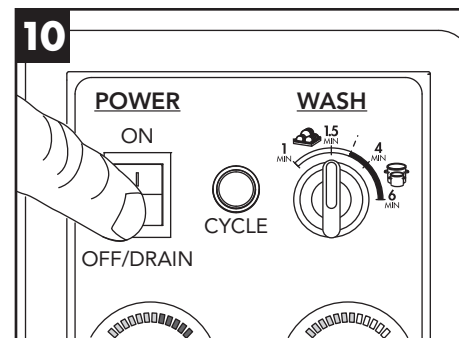

Push the power switch to the OFF/DRAIN position. The cycle light will not come on.

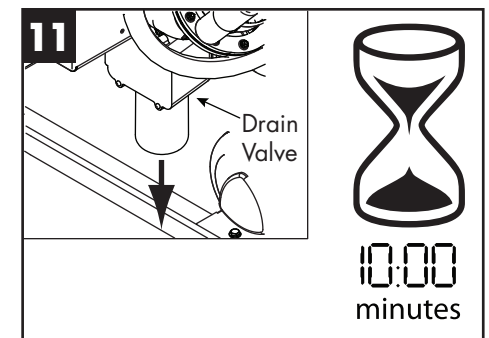

The automatic drain valve opens for 10 minutes to drain the machine.

# Tall Hood-type Series Operation/Cleaning Guide

# CLEANING

Every 2 hours and at the end of the day

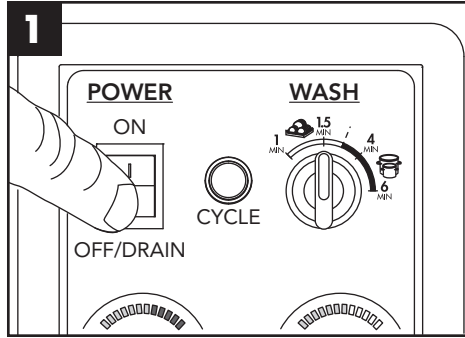

1 Push the power switch to the OFF/DRAIN position to drain.

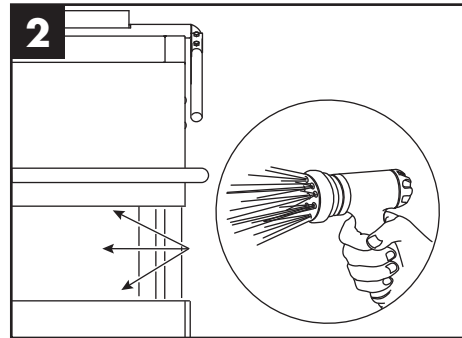

2 Spray the interior of the machine with fresh clean water.

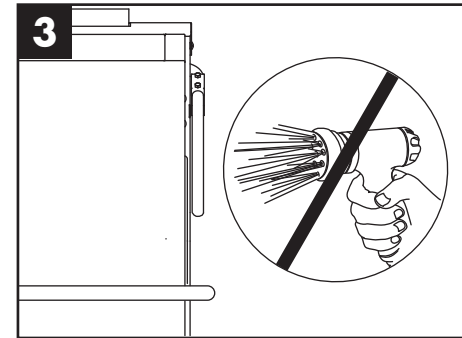

3 DO NOT spray the exterior of the machine with water.

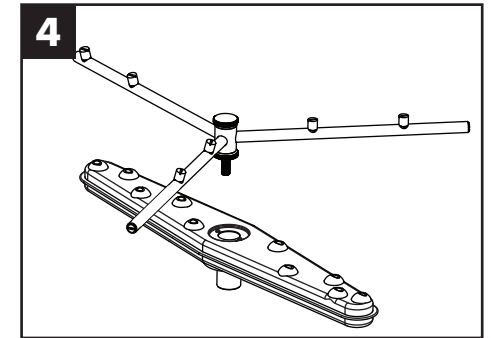

4 Remove the upper & lower spray arms and flush clean.

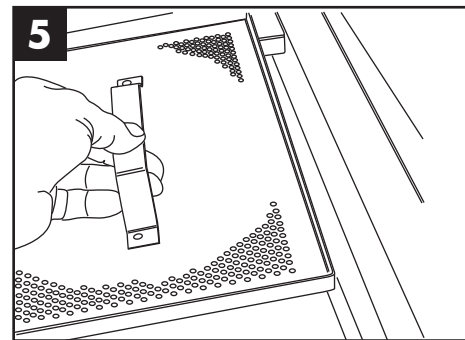

5 Remove the scrap screens from the machine.

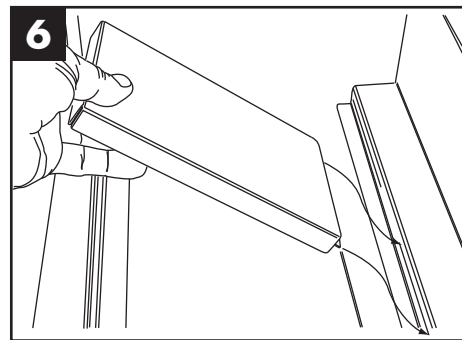

6 Remove the scrap screen support filler plate.

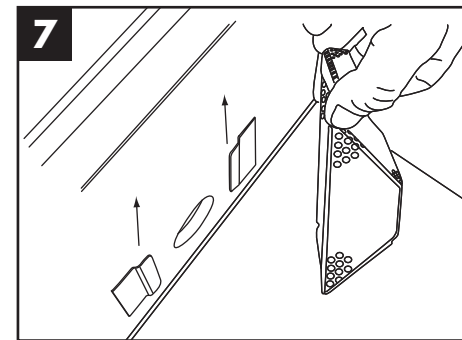

7 Remove the pump suction screen.

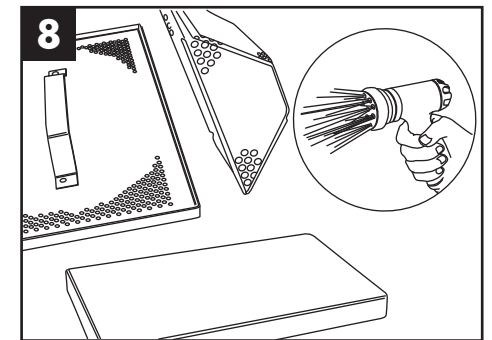

8 Back flush the screens and plate in a remote sink. DO NOT strike the screens against hard objects.

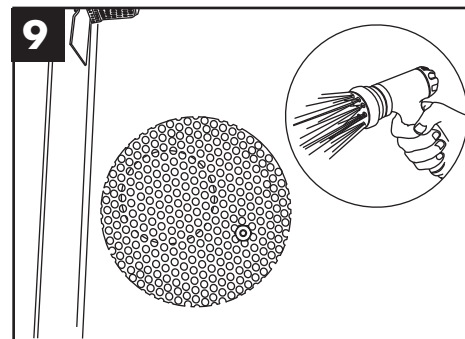

9 Clean the round drain screen & flush the bottom of the tank.

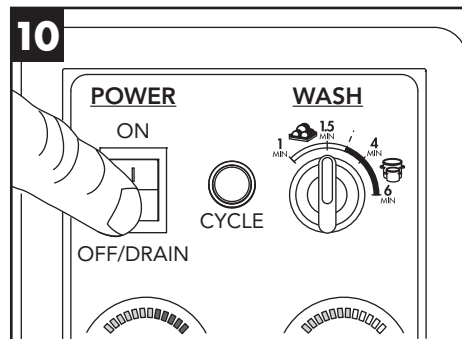

10 Push the power switch ON & immediately to the OFF/DRAIN position to drain.

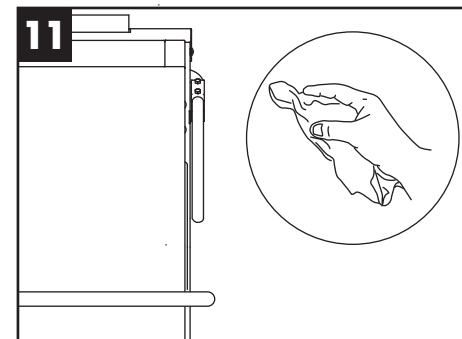

11 Wipe the exterior with mild detergent and dry with soft cloth.

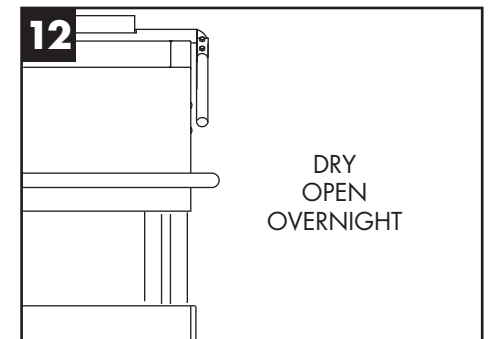

12 Reassemble machine and leave hood open to aid in overnight drying.