

# Champion<sup>®</sup>

## Waste Systems

### INSTALLATION



**Model:**

**SSG M3  
Slow Speed Grinder  
and Waterpress**

**Close-coupled and Remote**



Issue Date: 6.8.18

**Manual P/N 116088 rev. B**

For machines beginning with S/N SG18020035 and above

3765 Champion Boulevard  
Winston-Salem, NC 27105  
(336) 661-1556 Fax: (336) 661-1660  
Toll-free: 1 (800) 858-4477

2674 N. Service Road, Jordan Station  
Ontario, Canada L0R 1S0  
(905) 562-4195 Fax: (905) 562-4618  
Toll-free: 1 (800) 263-5798

Printed in the USA



## National Service Department

### In Canada:

Toll-free: (800) 263-5798  
Tel: (905) 562-4195  
Fax: (905) 562-4618  
email: [service@moyerdiebellimited.com](mailto:service@moyerdiebellimited.com)

### In the USA:

Toll-free: (800) 858-4477  
Tel: (336) 661-1556  
Fax: (336) 661-1660  
email: [service@championindustries.com](mailto:service@championindustries.com)

## ATTENTION

The model no., serial no., voltage, Hz and phase are needed to identify your machine.

**The machine data plate  
is located on the front  
of the control cabinet.**

Please have this information ready if you call for service assistance.

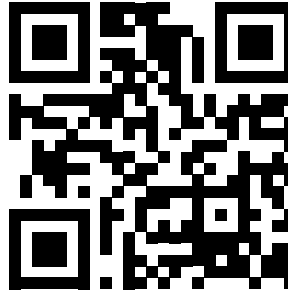

The USGBC Member Logo is a trademark owned by the U.S. Green Building Council and is used by permission. The logo signifies only that Champion Industries is a USGBC member; USGBC does not review, certify or endorse the products or services offered by its members.

# Revision History

Specifications are subject to change based on continual product improvement. Equipment owners may request a revised manual, at no charge, by calling 1 (800) 858-4477 in the USA or 1(800) 263-5798 in Canada.

<b>Revision Date</b>	<b>Revised Pages</b>	<b>Serial Number Effectivity</b>	<b>Revision Description</b>
4.25.18	All	SG18020035	Released First Edition
6.8.18	7-8	SG18050042	Added remote plumbing notes
	12-15	SG18050042	Added remote junction boxes

# SSG Installation Manual

## Table of Contents

Revision History .....	i
Load Warning .....	iv
Limited Warranty .....	v
Installation .....	1
Installation Codes .....	1
Safety Symbols .....	1
System Overview .....	2
Site Inspection .....	2
System Components .....	3
Receiving .....	3
Placement .....	3
Standard 9" Trough Adapter (Factory Supplied) .....	4
Trough Flush Gusher Head (Factory Supplied) .....	4
Silver Saver Grabber Magnet (Factory Supplied) .....	5
Hardware Kit (Factory Supplied) .....	5
Special Tools (Supplied by Others) .....	5
Control Cabinet and Start/Stop Station .....	5
Plumbing Connections .....	6
Cold Water Fill .....	6
Hot Water Flush .....	6
Plumbing Diagrams .....	7
Electrical Connections .....	9
Main Control Cabinet .....	9
Conduit Routing .....	10
Checking Motor Rotation .....	10
Control Cabinet Wiring .....	11
Junction Box Wiring .....	12

Operation .....	14
Pre-Operation System Checks .....	14
E-STOP Emergency Stop Switch .....	15
Normal Operation .....	16
Initial Fill .....	16
Run Mode- Balancing the System .....	17
Run Mode- Processing Waste .....	18
Cleaning .....	19
Clean Mode .....	19
Waterpress .....	20
Feed Trough .....	21
Extended Shutdown .....	21
Alarms .....	19
Door Open .....	22
Motor Overload .....	23
HMI Troubleshooting Screens .....	24
I/O = Inputs Screen .....	24
Outputs Screen .....	25
Maintenance Mode (Service Only) .....	26
Manual Control .....	26
Rinse Setpoints .....	29
Keypad .....	30
Clean Setpoints .....	30
Revision .....	31
Troubleshooting Chart .....	32

# LOAD WARNING - AVERTISSEMENT - ADVERTENCIA

English

## **ATTENTION**

This equipment is designed only for food waste reduction, (napkins, paper towels and cardboard are acceptable).

## **! LOAD WARNING !**

Do not load flatware, service ware, plastics, large bones, raw bones, (shells: clam, oyster, mussel, shrimp, crab, lobster, scallop, walnut, peanut, pecan, almond, or any other type of shell not listed), wood, or rags. Do not dump bulk quantities from tubs, garbage cans, or other large containers directly into the machine or feed troughs.

En Francais

## **ATTENTION**

Cet appareil est uniquement conçu pour la réduction de déchets alimentaires, (serviettes de papier et cartons sont également acceptables).

## **! AVERTISSEMENT DE CHARGE !**

Ne pas charger de coutellerie, d'ustensiles de service, de plastiques, d'os large ou cru, (de coquillage: praire, huitre, moule, crevette, crabe, homard, pétoncle, noyer, arachide, pacane, amande, ou tout autre type de noix ), bois, guenille. Ne pas déverser directement dans l'appareil ou dans l'auge, de grandes quantités de déchets, provenant de poubelles, cuves ou autres récipients en vrac.

En español

## **ATENCIÓN**

Este equipo es diseñado solamente para la reducción de residuos de alimentos, (servilletas, toallas de papel y cartón son aceptables).

## **! ADVERTENCIA DE CARGA!**

No cargue platos, cubiertos, utensilios de cocina, plásticos, huesos, grandes, huesos crudos, cáscaras o caracoles de (almeja, ostra, mejillón, camarón, cangrejo, langosta, vieira, nuez, maní, nuez de pacana, almendra o cualquier otro tipo de cascara o caracol aunque no aparesca en esta lista), madera o trapos. No use tinas, cestos de basura u otros envases para descargar grandes cantidades de residuos de alimentos directamente en la máquina, o en la entradas de canales.

## LIMITED WARRANTY AGREEMENT

Champion Industries (herein referred to as the "The Company"), 3765 Champion Blvd., Winston-Salem, North Carolina 27105, and 2674 N. Service Road, Jordan Station, Ontario, Canada, L0R 1S0, warrants machines, and parts, as set out below.

**Warranty of Machines:** The Company warrants all new waste processing machines of its manufacture bearing the name "Champion", "Trisys", or "Champion-Trisys" and installed within the United States and Canada to be free from defects in material and workmanship for a period of one (1) year after the date of installation or fifteen (15) months after the date of shipment by the The Company, whichever occurs first. Warranty registration must be submitted to the The Company within ten (10) days after installation either online at the Champion Industries website (<http://www.championindustries.com/warranty-registration>) or by fax to (336) 661-1660 in the USA or (905) 562-4618 in Canada. The Company will not assume any responsibility for extra costs for installation in any area where there are jurisdictional problems with local trades or unions.

If a defect in workmanship or material is found to exist within the warranty period, The Company, at its election, will either repair or replace the defective part or accept return of the machine for full credit. In the event that The Company elects to repair, the labor and work to be performed in connection with the warranty shall be done during regular working hours by a Champion authorized service technician. Defective parts become the property of The Company. Use of replacement parts not authorized by The Company will relieve The Company of all further liability in connection with its warranty. In no event will The Company's warranty obligation exceed The Company's charge for the machine.

**Approved Waste:** Only food, paper napkins, paper towels, and cardboard waste are approved for loading into the machine.

**Prohibited Waste:** Examples of prohibited waste that must not be loaded into the machine and not covered by the warranty include, but are not limited to:

- a. Flatware, service ware, plastics, large bones, raw bones, (shells: clam, oyster, mussel, shrimp, crab, lobster, scallop, walnut, peanut, pecan, almond, or any other type of shell not listed), wood, rags, or nitrile gloves.
- b. Loading bulk quantities of waste from tubs, garbage cans, or other large containers directly into the machine or feed troughs.
- c. Metal of any type.

**The following are not covered by the warranty:**

- a. Clogs or damage to any part of the machine due to the loading of prohibited waste.
- b. Replacement of fuses or resetting of overload breakers.
- c. Opening or closing of utility supply valves or switching of electrical supply current.
- d. Cleaning of valves, strainers, screens, nozzles, or spray pipes.
- e. Performance of regular maintenance and cleaning.
- f. Damages resulting from water conditions, accidents, alterations, improper use, abuse, tampering, improper installation, or failure to follow maintenance and operation procedures.

Examples of the defects not covered by the warranty include, but are not limited to: (1) Damage to the exterior or interior finish as a result of the above, (2) Use with utility service other than that designated on the rating plate, (3) Improper connection to utility service, (4) Inadequate or excessive water pressure, (5) Corrosion from chemicals dispensed in excess of recommended concentrations, (6) Failure of electrical components due to connection of chemical dispensing equipment installed by others, (7) Leaks or damage resulting from such leaks caused by the installer, including those at machine trough connections or by connection of chemical dispensing equipment installed by others, (8) Failure to comply with local building codes, (9) Damage caused by labor dispute.

Continued on next page.

## LIMITED WARRANTY AGREEMENT *(continued)*

**Warranty of Parts:** The Company warrants all new machine parts produced or authorized by The Company to be free from defects in material and workmanship for a period of 90 days from date of invoice. If any defect in material and workmanship is found to exist within the warranty period The Company will replace the defective part without charge.

**DISCLAIMER OF WARRANTIES AND LIMITATIONS OF LIABILITY.** THE COMPANY'S WARRANTY IS ONLY TO THE EXTENT REFLECTED ABOVE. THE COMPANY MAKES NO OTHER WARRANTIES, EXPRESS OR IMPLIED, INCLUDING, BUT NOT LIMITED, TO ANY WARRANTY OF MERCHANTABILITY, OR FITNESS OF PURPOSE. THE COMPANY SHALL NOT BE LIABLE FOR INCIDENTAL OR CONSEQUENTIAL DAMAGES. THE REMEDIES SET OUT ABOVE ARE THE EXCLUSIVE REMEDIES FOR ANY DEFECTS FOUND TO EXIST IN THE COMPANY'S WASTE PROCESSING MACHINES AND THE COMPANY'S PARTS, AND ALL OTHER REMEDIES ARE EXCLUDED, INCLUDING ANY LIABILITY FOR INCIDENTAL OR CONSEQUENTIAL DAMAGES.

The Company does not authorize any other person, including persons who deal in Champion dishwashing machines to change this warranty or create any other obligation in connection with Champion, Trisys and Champion-Trisys machines.

### AGREEMENT SIGNATURE

I acknowledge and agree that I have read and understand this Limited Warranty Agreement. I agree that the restrictions contained in this Limited Warranty Agreement are reasonable, proper and necessitated by The Company's legitimate interests and the legitimate interests of its subsidiaries and affiliated entities. I acknowledge and agree that I am entering into this Limited Warranty Agreement freely and with the intent to be bound by this Limited Warranty Agreement.

**ACCEPTED AND AGREED:**

**BUYER**

\_\_\_\_\_  
(Signature)

\_\_\_\_\_  
(Printed Name and Title)

Dated: \_\_\_\_\_



## Installation Codes

The installation of the SSG must comply with all local electrical, plumbing, health and safety codes or in the absence of local codes, installed in accordance with the applicable requirements in the National Electrical Code, NFPA 70, Canadian Electrical Code (CEC), Part 1, CSA C22.1.



**NOTE:**

Only qualified personnel familiar with the installation of food service equipment should attempt the installation of this machine. Damage or problems associated with improper installation will not be covered by the dishwasher limited warranty.

## Safety Symbols

The following symbols are used throughout this manual to alert the reader to important information.



**WARNING:**

Warning statements indicate a condition or practice that can result in personal injury or possible death.



**DANGER:**  
THE GRINDER CONTAINS ROTATING CUTTERS.  
DO NOT OPERATE WITHOUT GUARDS IN PLACE.



**CAUTION:**

Caution statements indicate a condition or practice that can result in damage to the machine or associated equipment.



**NOTE:**

Note statements highlight important information necessary for the operation of the machine.

# System Overview

The SSG food waste processing system consists of a slow speed grinder to macerate a combination of 70% food and 30% paper. The waste is mixed with water to produce a slurry. The slurry is pumped to a waterpress that separates the water producing a semi-dry pulp. The water is recirculated to a feed trough system as the pulp is discharged into the customer's waste containers.

**SSG close-coupled (SSG-C):** The grinder, slurry tank, recirculation tank, pumps, waterpress form a single unit. The main control cabinet is wall-mounted with an unmounted start/stop station.

**SSG Remote (SSG-R):** The grinder and slurry tank form one unit and the recirculation tank, recirc pump, and waterpress form the second unit. The main control cabinet is wall-mounted with an unmounted start/stop station.

## Site Inspection



### CAUTION:

An approved copy of the plumbing and electrical, P&E, drawing must be present at the installation site. Improper installation is not covered by the limited warranty. Check the site electrical and plumbing to ensure they match those on the P&E.

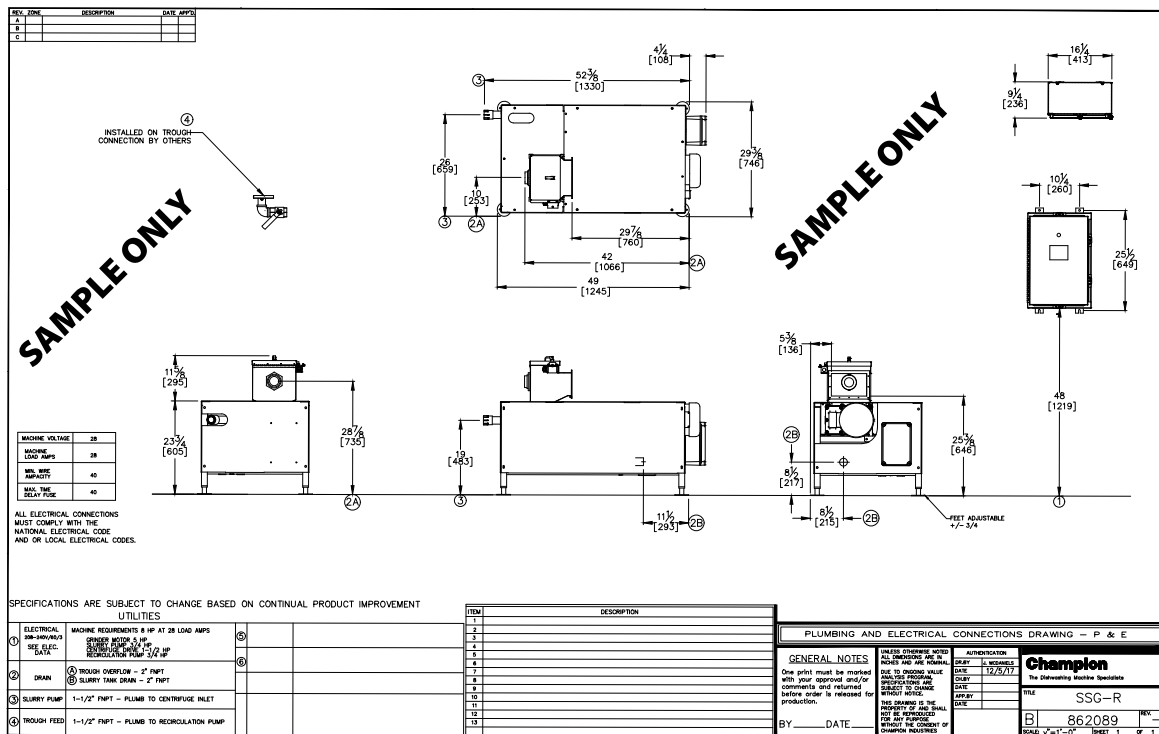

Fig. 1 - The P&E drawing must be present at the installation site.

# Components

## Receiving

Inspect the machine for damage. If damaged, save the packing material and immediately report damage to a supervisor. The system may have shipped on more than one pallet. Check the shipping container for parts and accessories that shipped with the machine.

## Placement

- The SSG may have shipped on multiple pallets. Remove the unit(s) from the pallet(s) and move to their permanent location.
- Place the grinder and waterpress no less that 2 feet apart.
- Adjust the height and level of the machines using the adjustable legs. Level the components from side-to-side and front-to-back.



### CAUTION:

Use care when moving the machine components to prevent damage. Damage due to improper moving is not covered by the limited warranty.

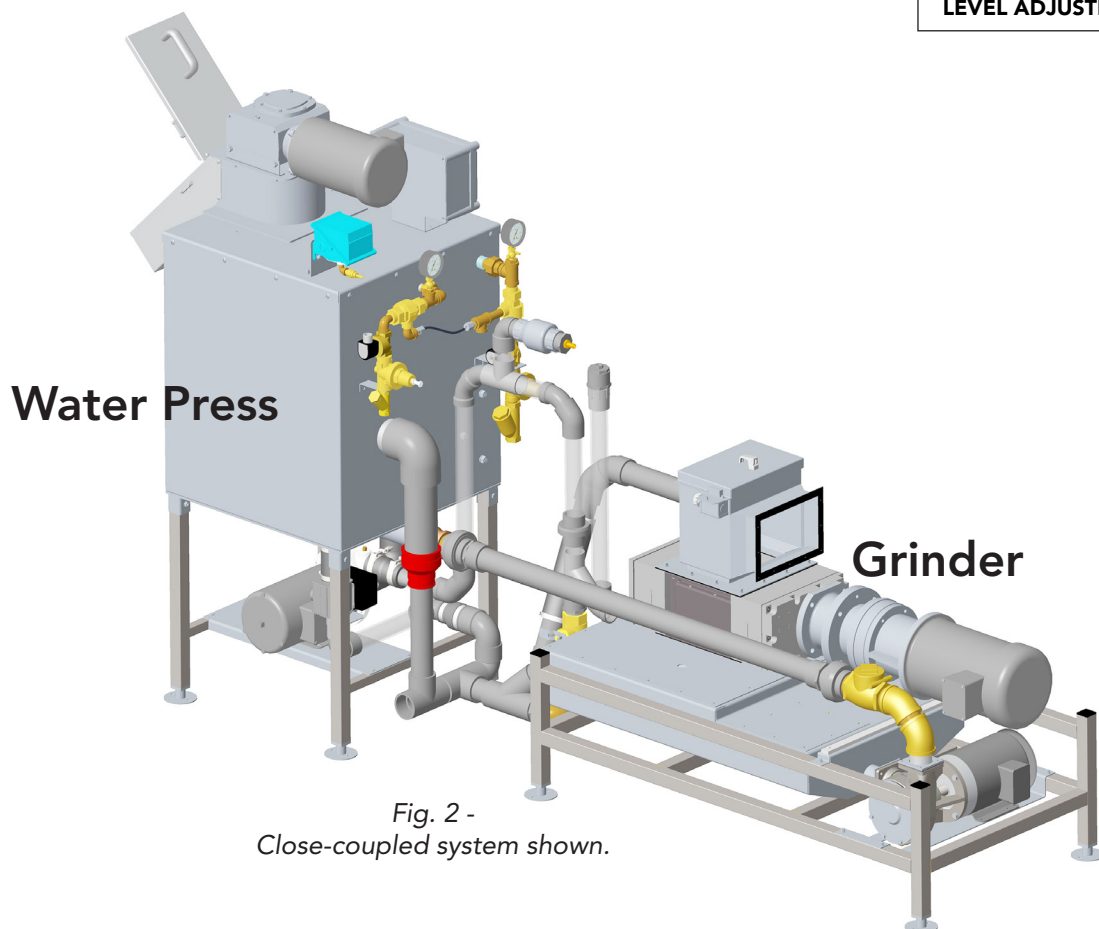
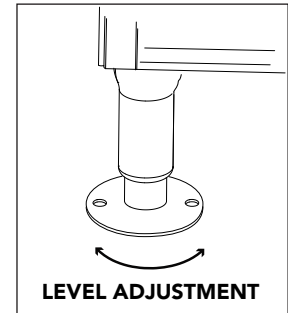

Fig. 2 -  
Close-coupled system shown.

# Components

## Standard 9" Trough Adapter (Factory Supplied)

The grinder unit is equipped with a 9" opening trough adapter to connect a feed trough, (supplied by others), to the inlet of the grinder. The adapter is shipped with a rubber gasket, P/N 111873, and fasteners.

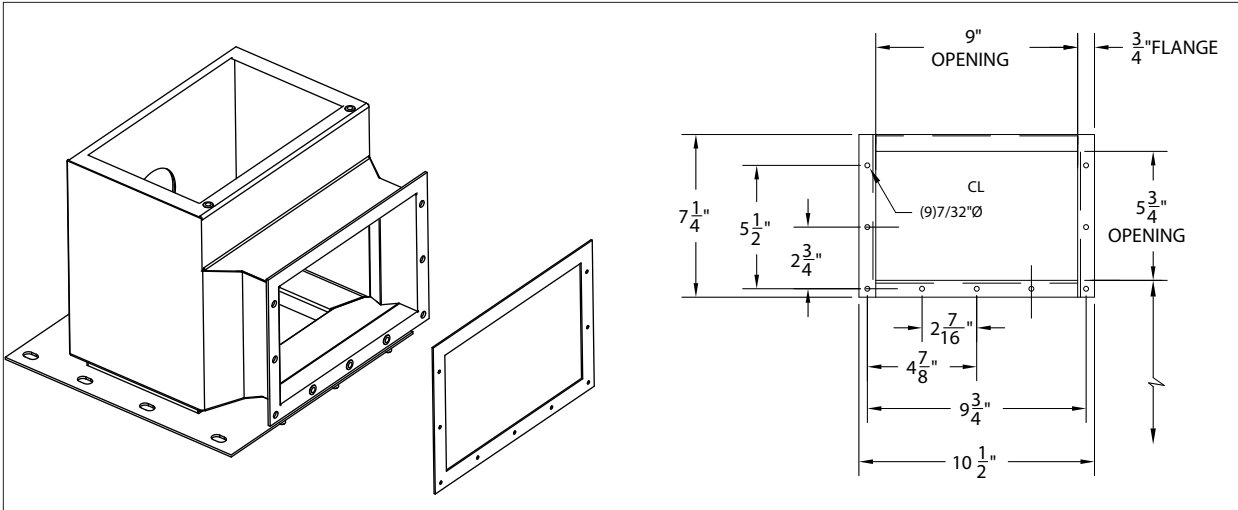

Fig. 3

## Trough Flush Gusher Head (Factory Supplied)

A gusher head and 1-1/2" shut-off valve supplies recirculated water from the SSG to the trough. The gusher head may ship with the SSG or sent to the trough fabricator.

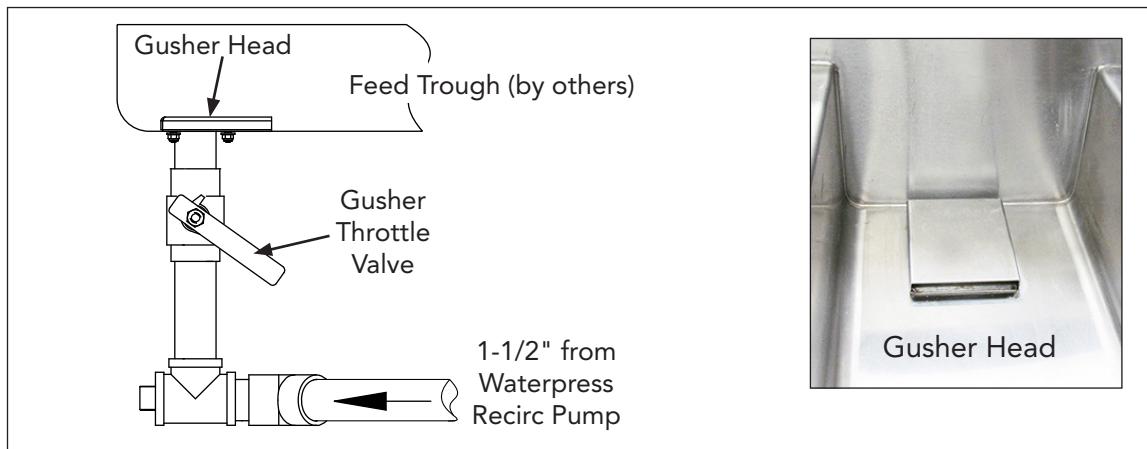

Fig. 4

### Silver Saver Grabber Magnet (Factory Supplied)

Permanent magnets are standard equipment to prevent silverware and other ferrous metals from entering the grinder unit. The magnets are usually shipped to the trough fabricator for installation.

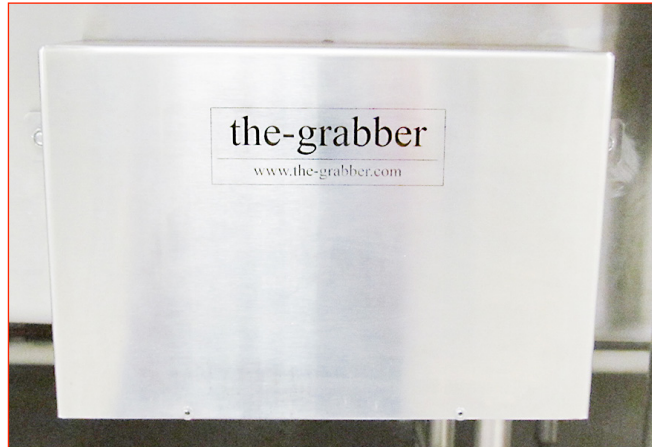

Fig. 5

### Hardware Kit (Factory Supplied)

The trough adapter gasket, fasteners, and conduit fittings are packaged and placed inside the trough adapter.

### Special Tools (Supplied by Others)

The following special tools are needed for the installation.

(1) 3/8" electric drill, (1) 1-3/8" hole saw for 1" conduit, (1) 7/8" hole saw for 1/2" conduit.

### Control Cabinet and Start/Stop Station

The main control cabinet is wall-mounted and installed by others. The cabinet is equipped with a 20 feet whip from the control cabinet to the grinder junction box and a 12 foot whip from the grinder junction box to the start/stop station. Longer whips and wire connections are supplied by others.

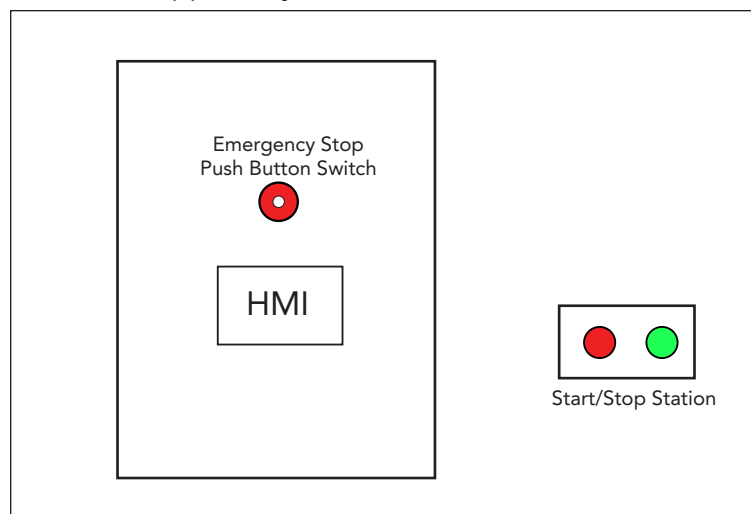

Fig. 6

## Plumbing Connections

Connections must comply with local safety, sanitary, and plumbing codes.



**CAUTION:** The installing plumber must thoroughly flush debris from the water supply line before connecting it to the machine.

### Cold Water Fill:

Connect a 3/4" FNPT cold water supply to the waterpress tank fill line. The minimum incoming temperature is 36°F/2°C. Install a shut-off valve as close to the connection as possible for servicing.

### Hot Water Flush:

Connect a 1/2" FNPT hot water supply to the waterpress flushing supply line. The incoming min/max water temperature is 110°F/33°C - 140°F/60°C. Install a shut-off valve as close to the connection as possible for servicing.

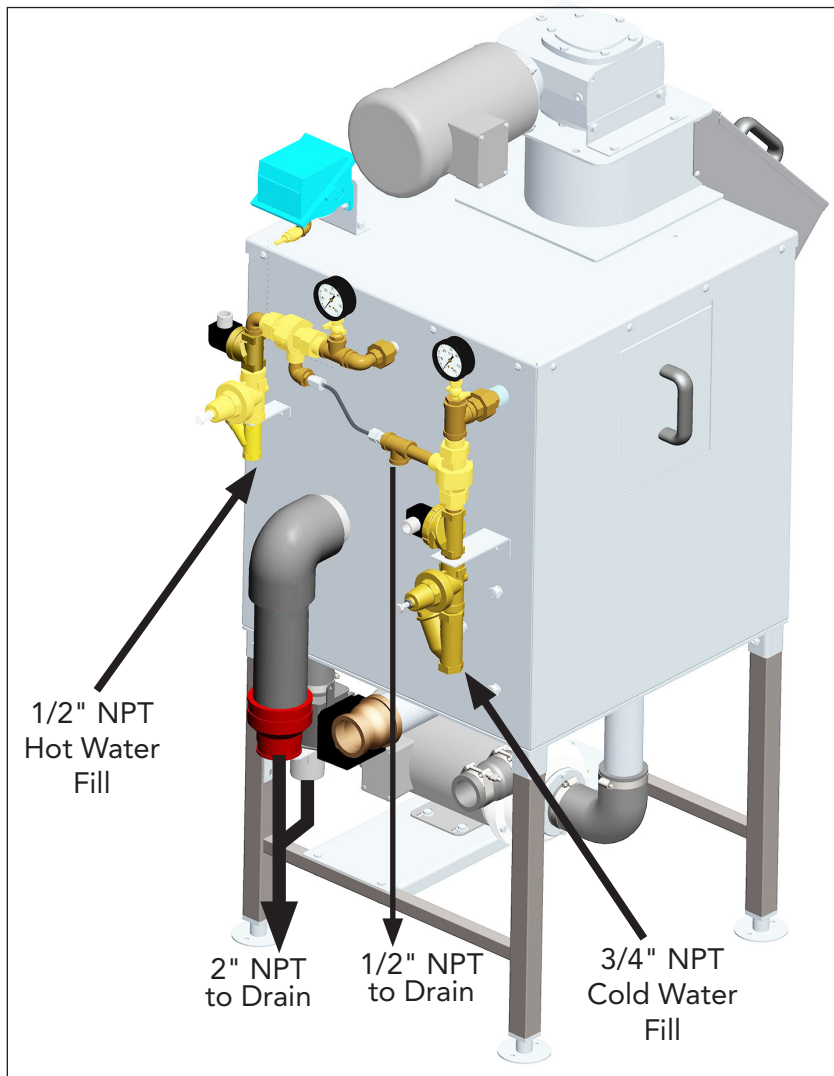

Fig. 7

## Plumbing Diagrams

- Interconnecting plumbing was disconnected at the factory and shipped with the machine.
- Refer to the diagram below and the illustrations on the next page to reassemble the plumbing.
- Additional plumbing required to reach building drains are supplied by others.



**STOP!**  
**ALWAYS REFER TO ANY PLUMBING DIAGRAMS SUPPLIED WITH THE MACHINE BEFORE INSTALLING AND MAKING CONNECTIONS.**

**PLUMBING CONNECTIONS MAY BE LABELED TO ASSIST THE PLUMBING REASSEMBLY.**

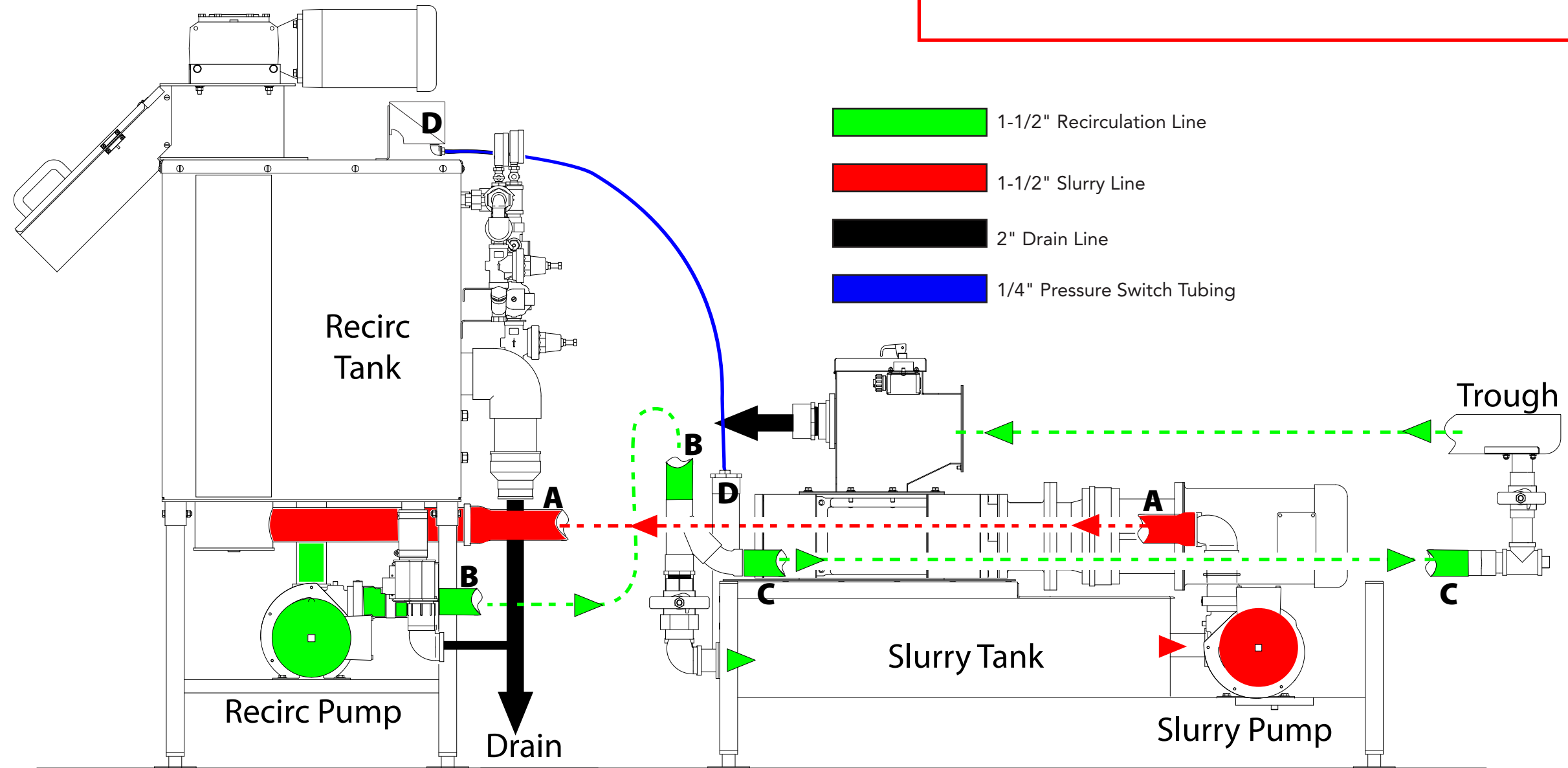

Fig. 8



# Plumbing Diagrams



**STOP!**  
ALWAYS REFER TO ANY PLUMBING DIAGRAMS SUPPLIED WITH THE MACHINE **BEFORE** INSTALLING AND MAKING CONNECTIONS.  
  
PLUMBING CONNECTIONS MAY BE LABELED TO ASSIST THE PLUMBING REASSEMBLY.

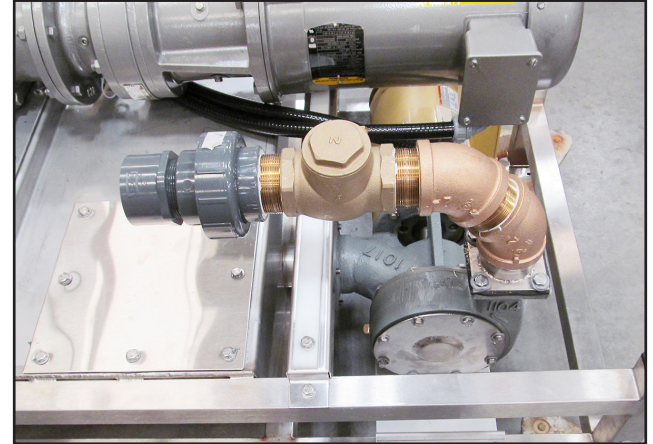
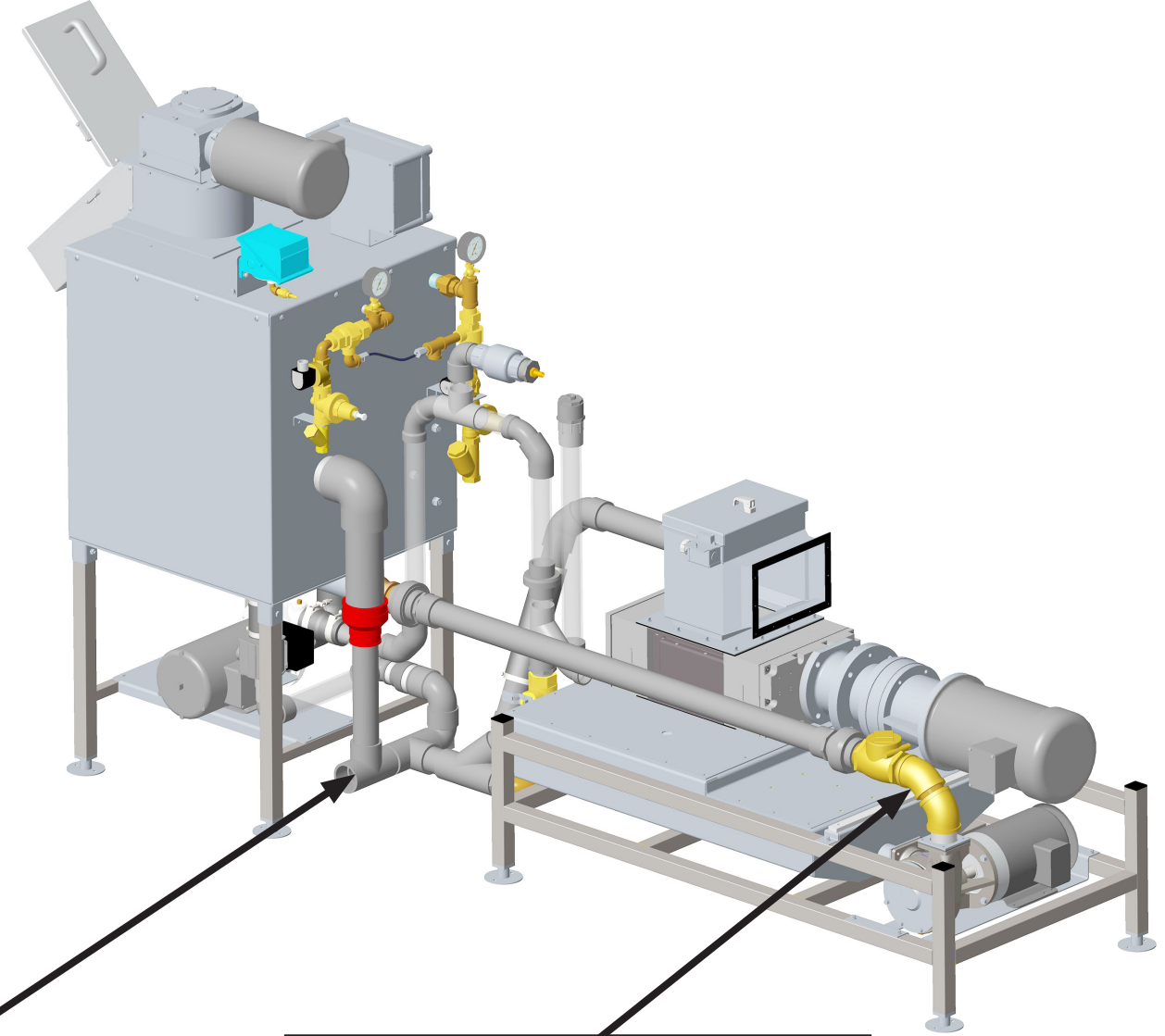
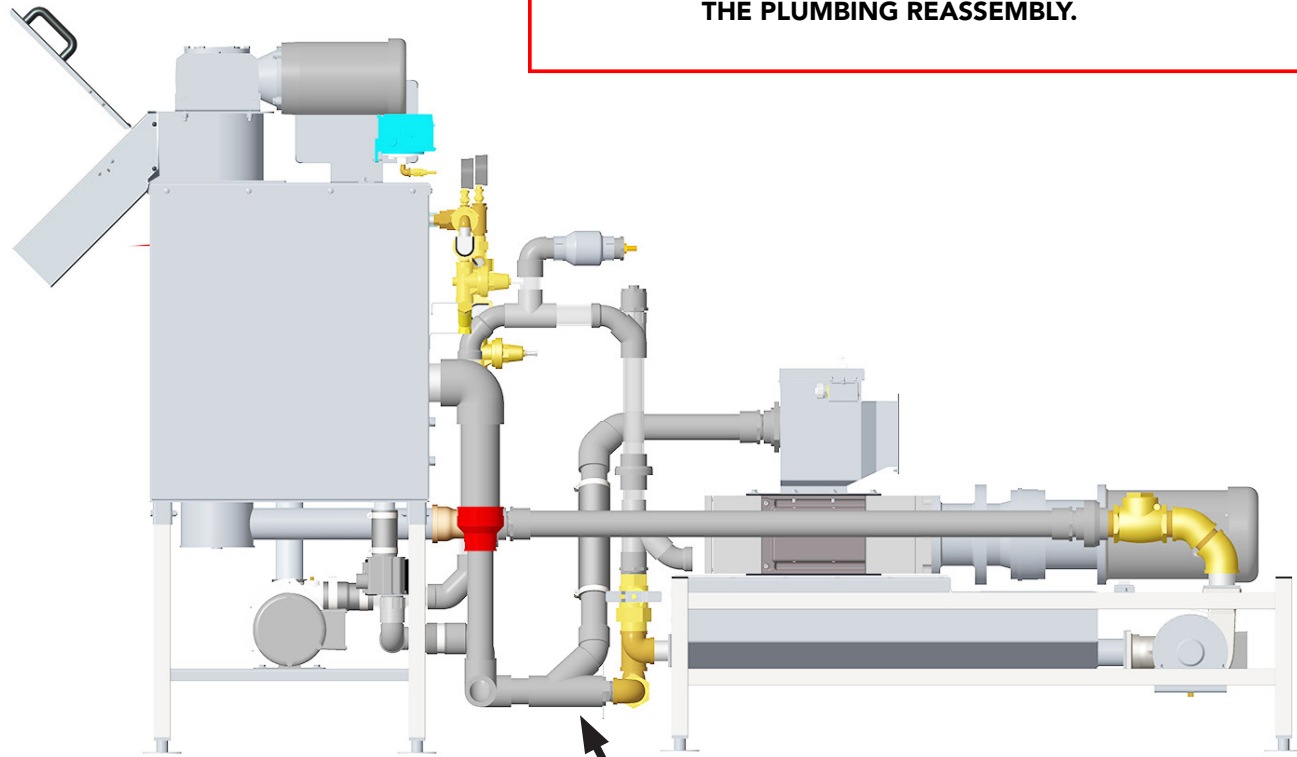

Fig. 9 -  
Sample close-coupled assembly shown



# Electrical Connections

## Main Control Cabinet



**WARNING:** Electrocution may occur when working on energized circuits. Disconnect power at the main breaker or service disconnect switch, then lock out and tag it to indicate that work is being performed on the circuit.

- Install the wall-mounted control cabinet 48"/1219 mm above the finished floor. Junction boxes are located on the grinder and the waterpress as well. Remote systems have an additional Emergency Stop on the waterpress.
- Factory conduit/wire assemblies are located in the \* marked areas.
- Additional holes and wiring not supplied at the factory must be supplied by others and installed in the same \* areas.
- Electrical schematics are located inside the wall-mounted control cabinet.

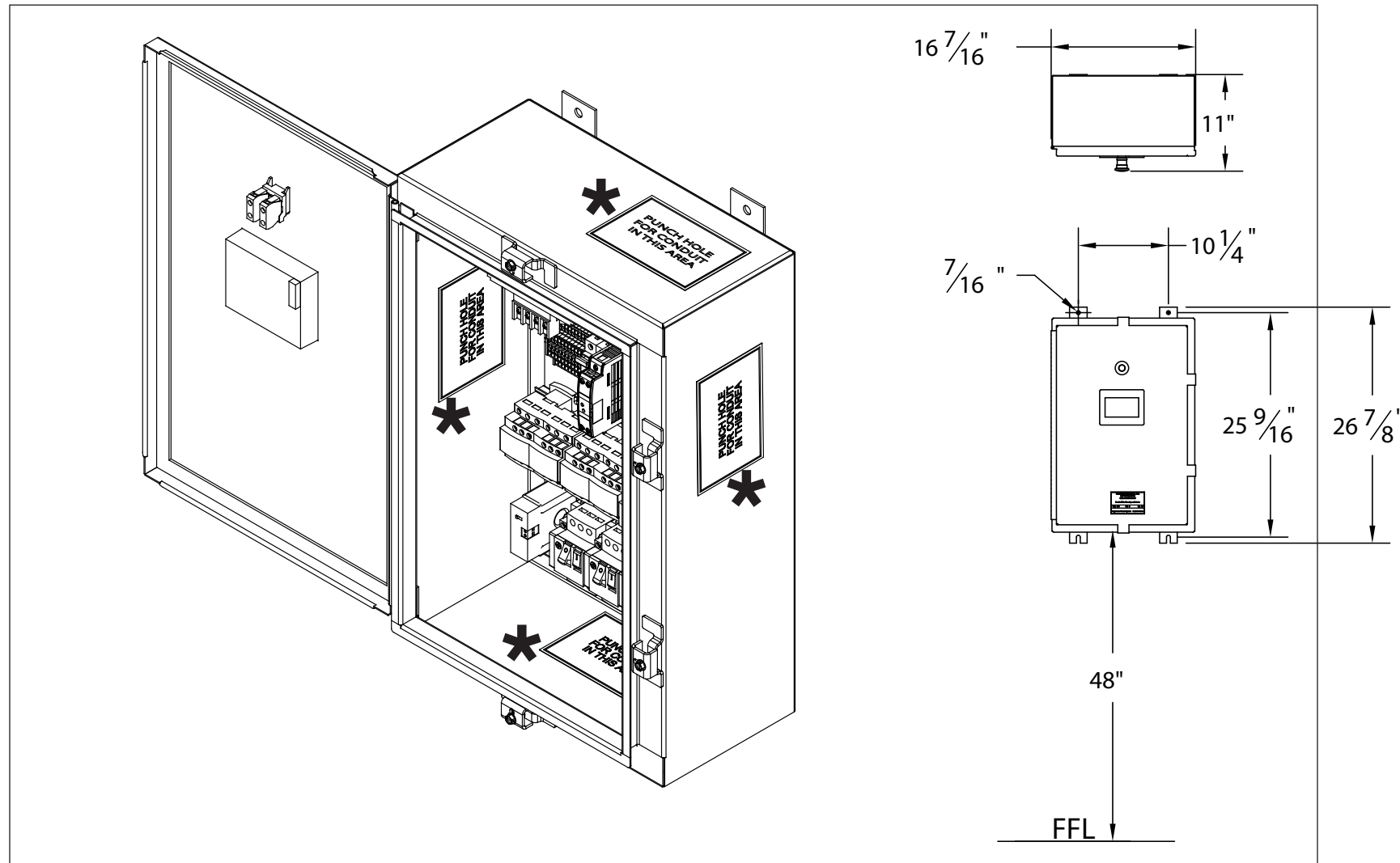

Fig. 10

- Ensure the UL508A Data Plate electrical requirements match the installation site. **A**
- Connect incoming power to the control cabinet input terminal block. **B**
- If required, connect the control wires at the terminals to the left of the PLC. **C**
- If required, connect the motors at the bottom of the control cabinet. **D**

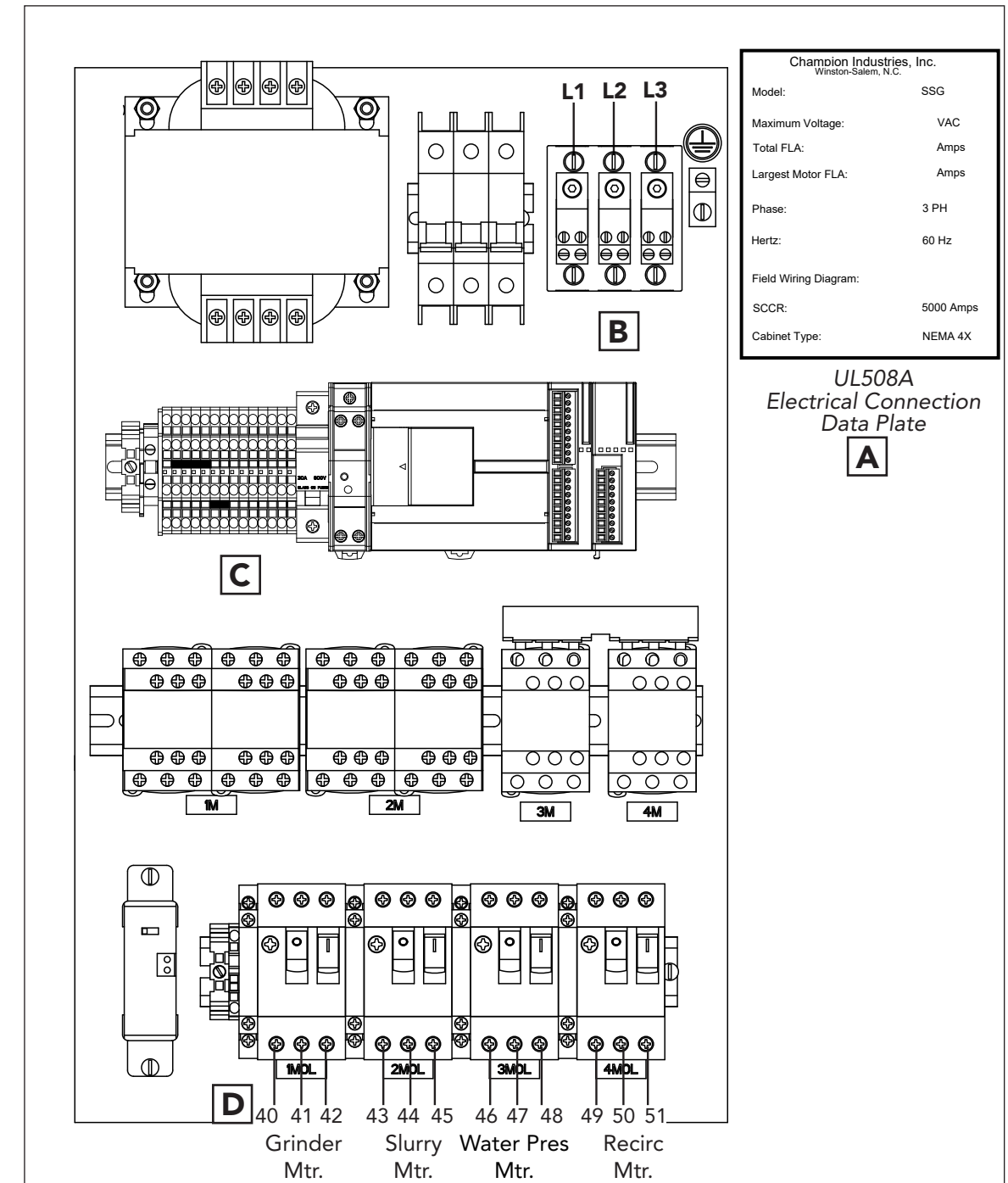

Fig. 11

## Electrical Connections (continued)

### Conduit Routing

Note the illustrations to the right for close-coupled and remote systems.

#### Close-coupled systems:

- Contains: main control cabinet, grinder and waterpress junction boxes, start/stop station.
- Whips: 20' waterpress/control cabinet, 20' grinder/control cabinet, 12' grinder to start/stop station.
- Whips and junction boxes labeled for easy identification.

### Checking Motor Rotation

- All the motors are wired to rotate in the same direction at the factory. Proper motor rotation is clockwise when viewed from the rear.
- **To reverse motor rotation: DISCONNECT MAIN POWER.** Reverse L1 and L2 wires at the input terminal block located at the top of the main control cabinet. Reconnect power and bump the motors to verify the motor rotation is correct.

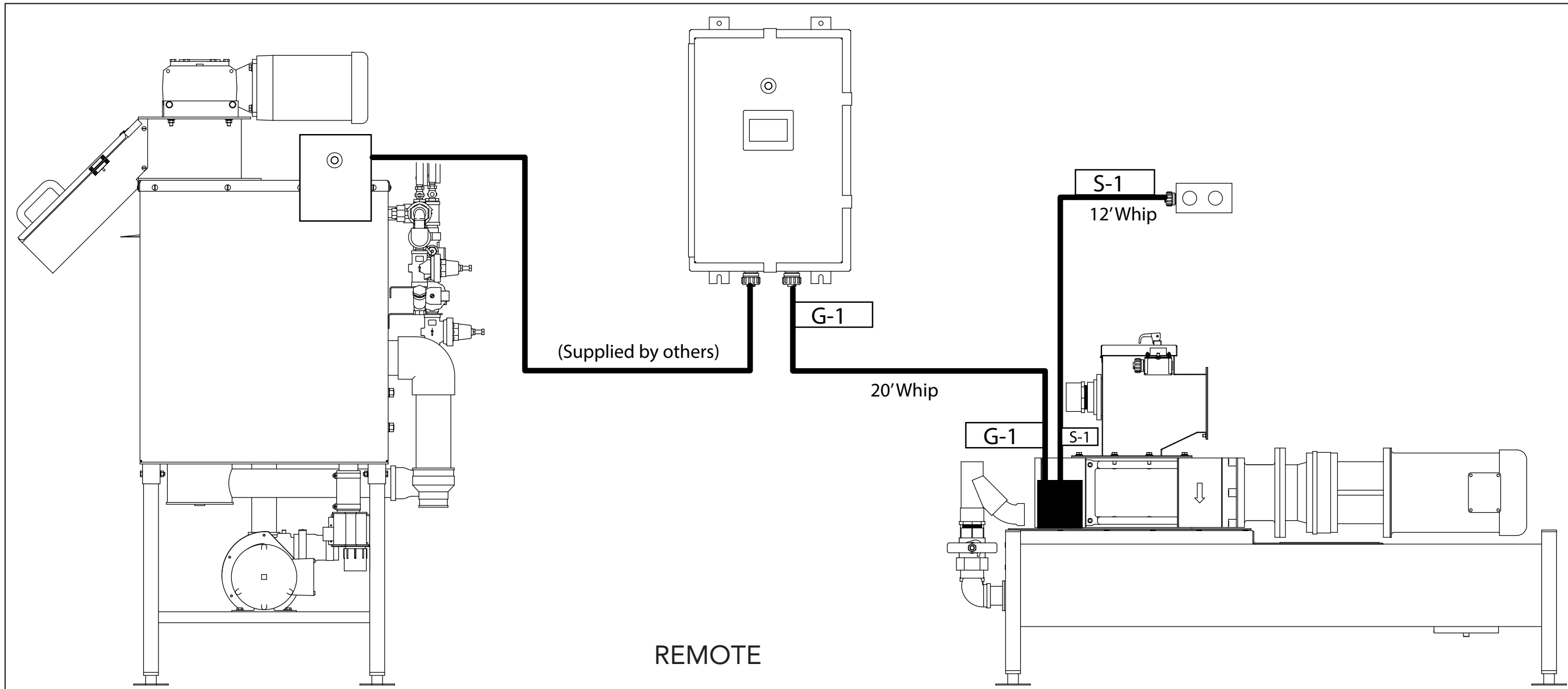

# Control Cabinet Wiring- Close-coupled System



**WARNING:**  
**ALWAYS CONSULT THE WIRING SCHEMATICS INCLUDED WITH THE MACHINE BEFORE CONNECTING OR ALTERING ANY WIRING.**

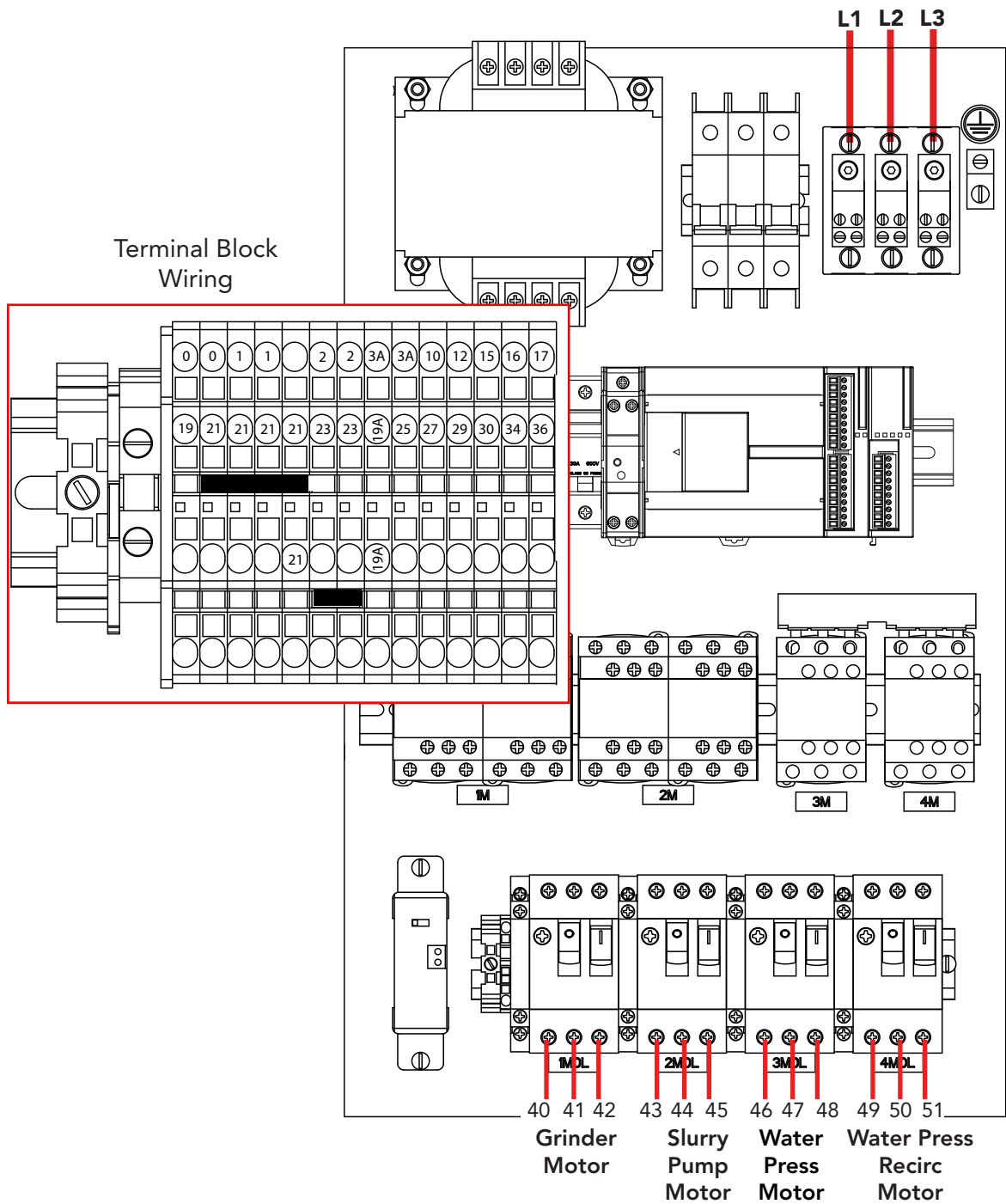

Fig. 13a

# Control Cabinet Wiring- Remote System



**WARNING:**  
**ALWAYS CONSULT THE WIRING SCHEMATICS INCLUDED WITH THE MACHINE BEFORE CONNECTING OR ALTERING ANY WIRING.**

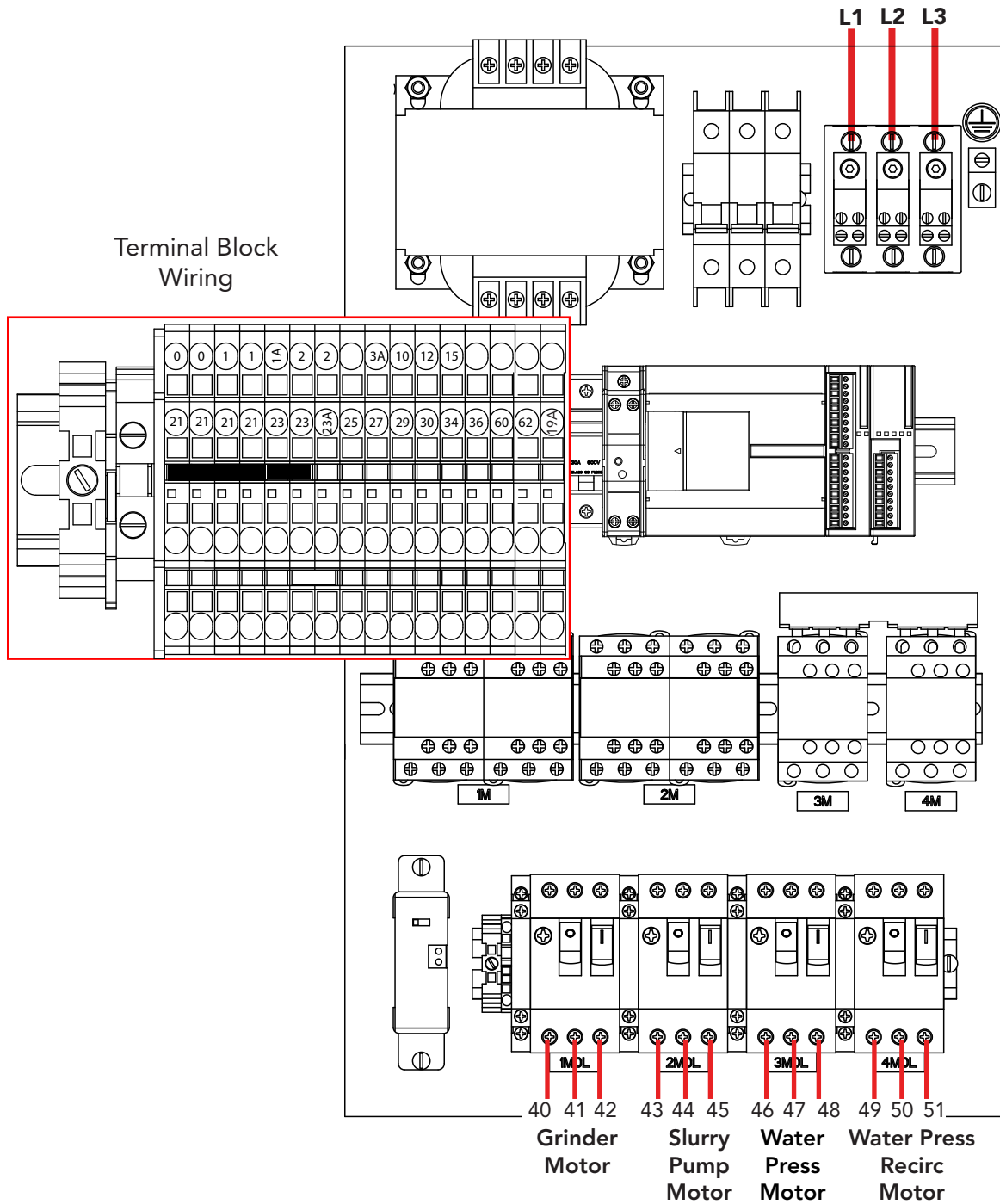

Fig. 13b

# Junction Box Wiring

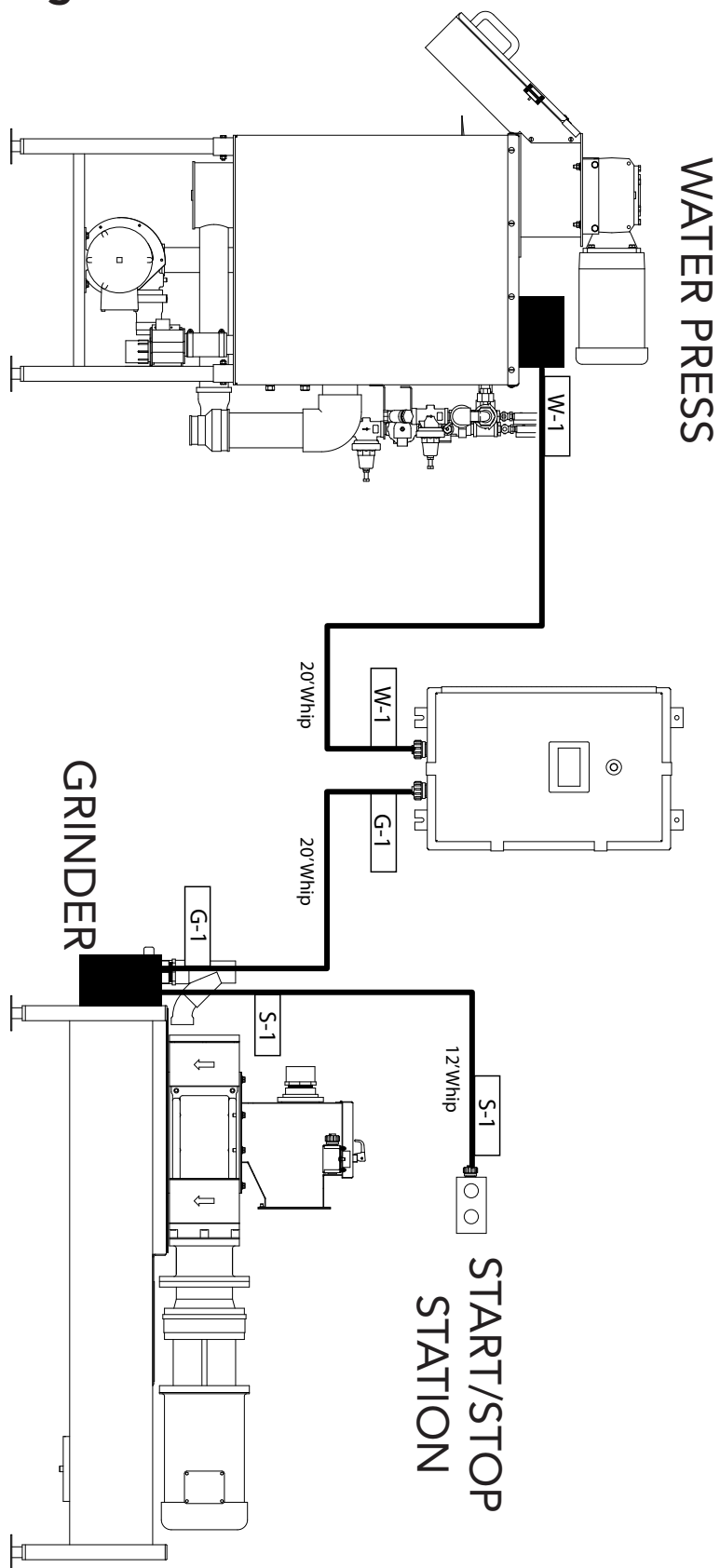

Fig. 14



# Junction Box Wiring- Close-coupled



**WARNING:**  
ALWAYS CONSULT THE WIRING SCHEMATICS INCLUDED WITH THE MACHINE BEFORE CONNECTING OR ALTERING ANY WIRING.

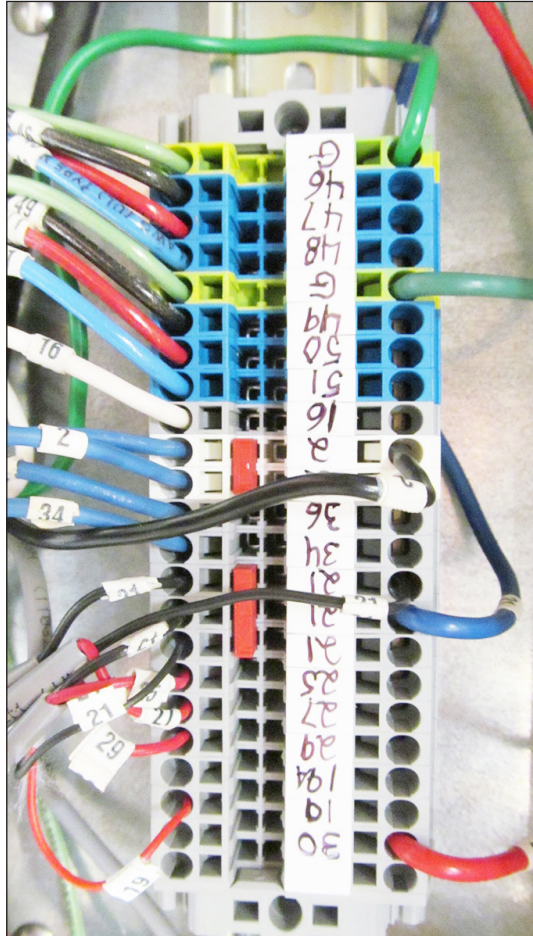

WATER PRESS

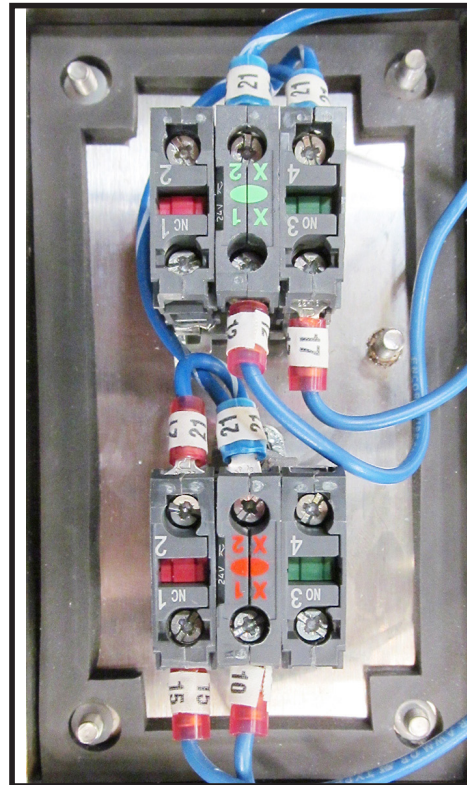

START/STOP  
STATION

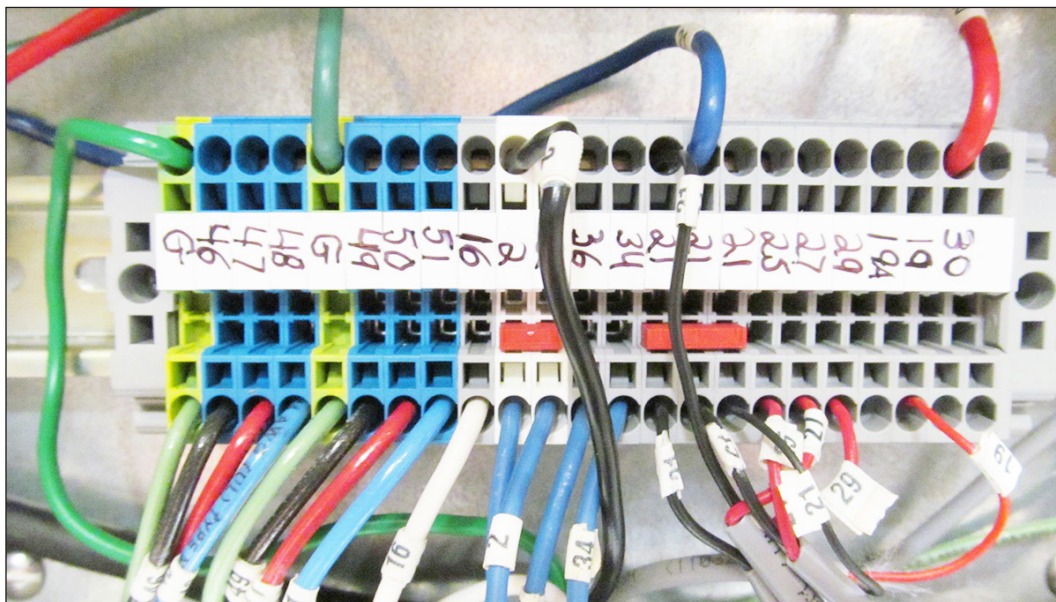

GRINDER



# Junction Box Wiring- Remote



**WARNING:**  
ALWAYS CONSULT THE WIRING SCHEMATICS INCLUDED WITH THE MACHINE BEFORE CONNECTING OR ALTERING ANY WIRING.

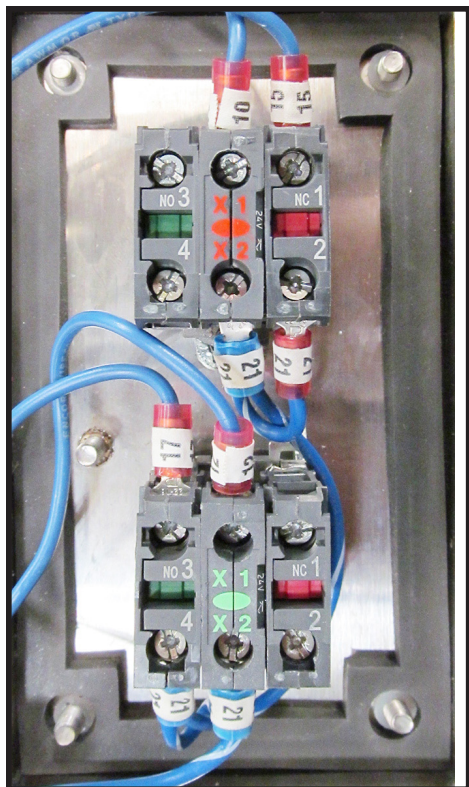

START/STOP  
STATION

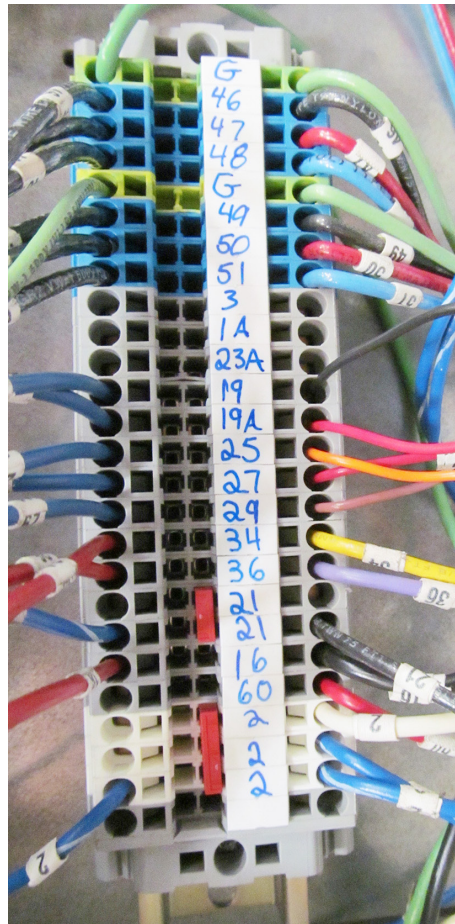

WATERPRESS

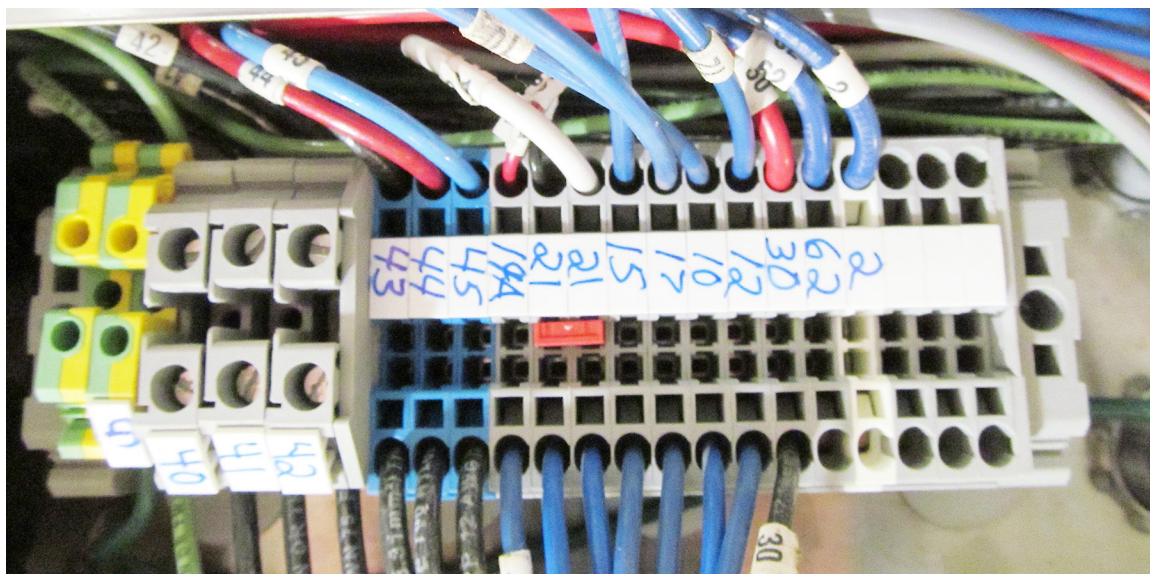

GRINDER

# Operation

## Pre-Operation System Checks

- Is the Emergency Stop, (E-Stop), button (A) on the front of the control cabinet off?
- Is the grinder free of debris?
- Is the grinder access door (B) closed and latched?
- Is the waterpress interior clear of debris?
- Is the waterpress access door (C) in place?
- Is the waterpress discharge chute (D) closed?
- Is a waste container (E) under the discharge chute?
- Is the trough gusher head valve open?
- Are the drain valves closed?
- Are the floor drains clear?
- Is the water supply on?
- Are there any water leaks around the system?

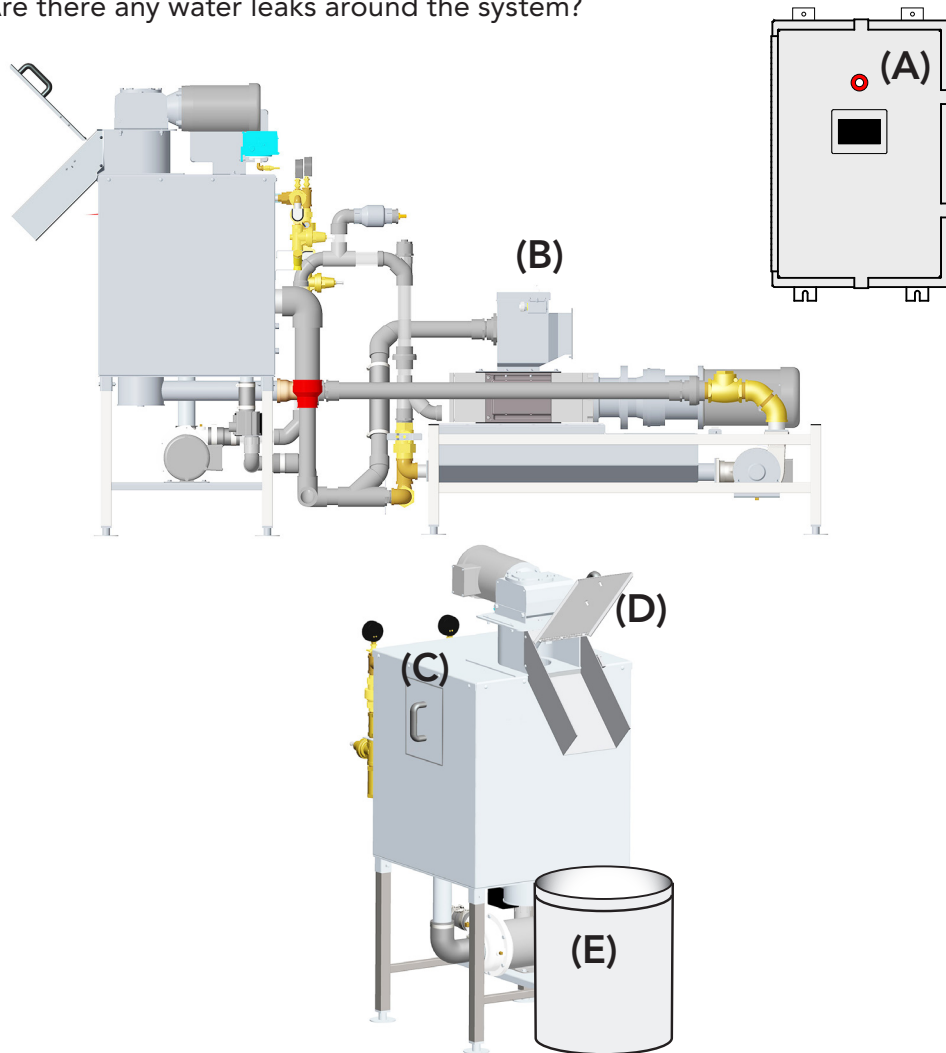

Fig. 15



# E-STOP EMERGENCY STOP SWITCH



**WARNING:**  
THE E-STOP IS USED ONLY FOR AN EMERGENCY.

- The E-STOP is a red round button located at the top the main control cabinet.
- Press to immediately stop the system.
- The red start/stop button will begin to flash.
- To reset: Turn the button 1/4 turn CW and pull out.

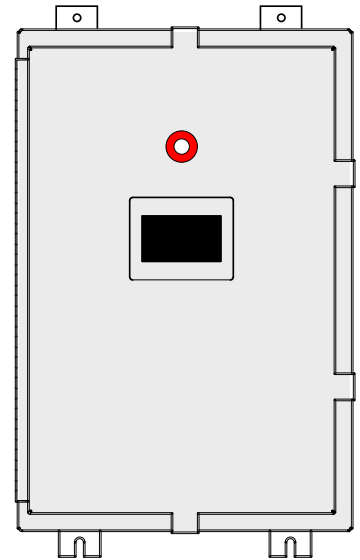

Fig. 16

- DO NOT use the E-STOP as a **normal** system shutdown operation.
- DO NOT load waste into the machine during an E-STOP.
- DO NOT use the E-STOP to clean the machine.

# Operation

## Normal Operation

- Turn power on at the building breaker panel.
- HMI shows 'READY'.
- Green start/stop station button flashes.

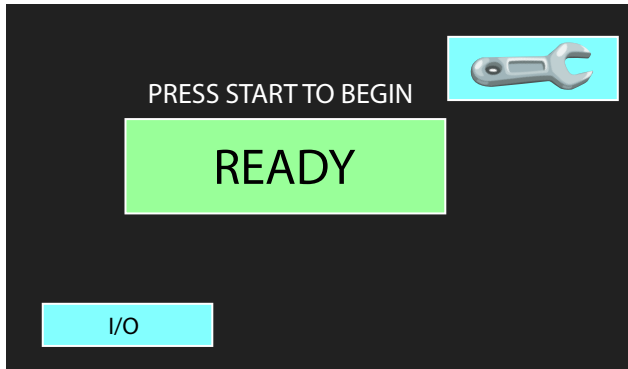

DISPLAY	DESCRIPTION
READY	Indicates the machine is ready to operate
Wrench Symbol	For Service Technician Only
I/O	Accesses the Input/Output Menu

## Initial Fill

- Push the flashing green start/stop station button.
- HMI shows 'FILLING'.
- Waterpress tank fills.

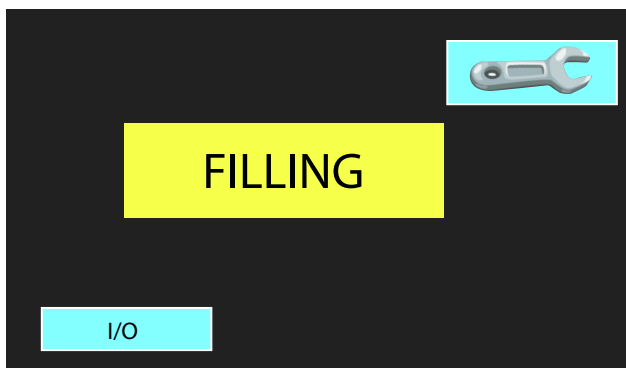

## Run Mode - Balancing the System

- The HMI shows 'READY' when the waterpress is full of water.
- The green start/stop station button turns solid green.
- Push the flashing green start/stop station button. System runs.
  - HMI shows "RUNNING".

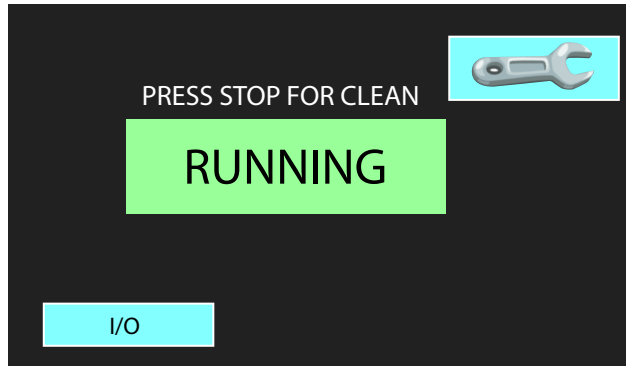

- All pumps run, Waterpress and grinder run, Trough gusher runs.
- Set the waterpress recirc valve (A) three quarter open.
- Set the trough flush valve (B) three quarter open.

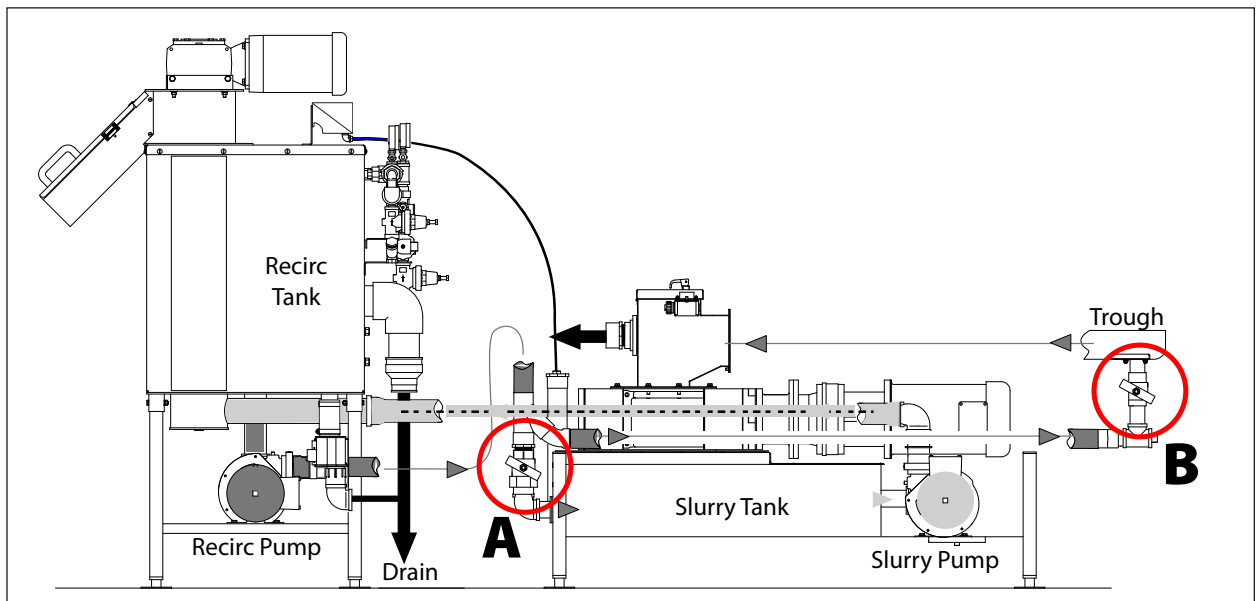

Fig. 17

- Set the waterpress recirc valve (A) 3/4 turn open.
- Set the trough flush valve (B) 3/4 turn open.
  - WITHOUT LOADING WASTE -
- The waterpress water level will be at or below the middle float.
- The recirc pump and the slurry pump will cycle back and forth. This is normal.
- There should be good water flow in the water trough.

Continued on next page.

## Operation

### Run Mode - Balancing the System (continued)

- Slurry pump turns off if pressure switch has NOT been made for 10 seconds.
- Slurry pump remains off until pressure switch is made.
- When pressure switch is made for 10 sec. and the waterpress middle float has NOT been made for 10 secs:
  - a) slurry pump and recirc pump turn off
  - b) slurry pump restarts after 3 secs.
  - c) recirc pump restarts when waterpress middle float is made
- The following happen simultaneously when the pressure switch is made for 15 secs. and the waterpress upper float is made:
  - a) recirc pump turns off until the pressure switch is not made for 3 secs.
  - b) automatic drain valve opens until the pressure switch is not made for 3 secs.

### Run Mode - Processing Waste

- WASTE LOAD MUST BE 70% FOOD AND 30% PAPER.



#### WARNING:

Do not load flatware, service ware, plastics, large bones, raw bones, (shells: clam, oyster, mussel, shrimp, crab, lobster, scallop, walnut, peanut, pecan, almond, or any other type of shell not listed), wood, or rags. Do not dump bulk quantities from tubs, garbage cans, or other large containers directly into the machine or feed troughs.

- Ensure all access doors are closed.
- Ensure a waste container is positioned underneath the discharge chute.
- Load food waste, paper, and reduced cardboard into the waste trough.
- The waste water will turn a milky color.
- A wet pulp will begin to appear around the waterpress screen.
- A semi-dry pulp will begin to exit the waterpress discharge chute.



#### NOTE:

The amount and consistency of the discharge depends upon the waste being fed into the system.

# Cleaning

## Clean Mode



### CAUTION:

DO NOT ADD WASTE TO THE SYSTEM DURING THE CLEAN MODE.

- The HMI shows 'RUNNING'. The green start/stop station button is solid green.
- Push the red start/stop station button. All motors stop.
- The green start/stop station button begins to flash.
- The automatic drain valve opens until the lower float drops out.
- The drain valve closes/fill valve comes on.
- Fills until upper float is made.
- System runs for 10 secs.
- The waterpress drains and fill three times.
- The HMI shows 'CLEAN' for 10 minutes (seconds remaining is displayed on HMI).
- Clean mode stops.
- HMI shows 'READY'.
- Green start/stop station button is solid green.
- The automatic drain valve remains open for 10 minutes.

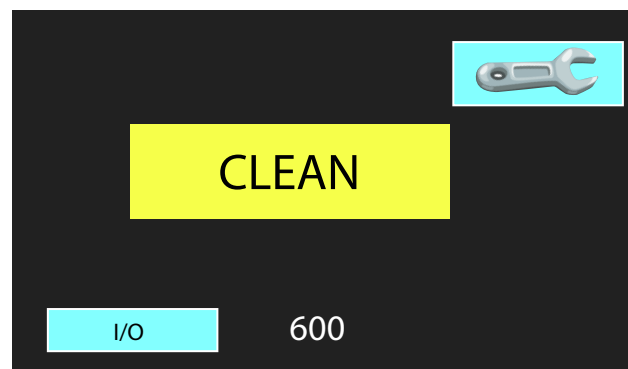

Continued on next page.

## Cleaning (continued)

### Waterpress Cleaning

- Perform a system Clean Mode, to drain the tank.
- Remove the waterpress access door (A).
- Thoroughly flush the screen (B) and use a plastic bristle brush to remove large particles.
- Open the discharge chute and flush the waterpress cone to remove large particles.
- Flush the bottom of the waterpress tank.

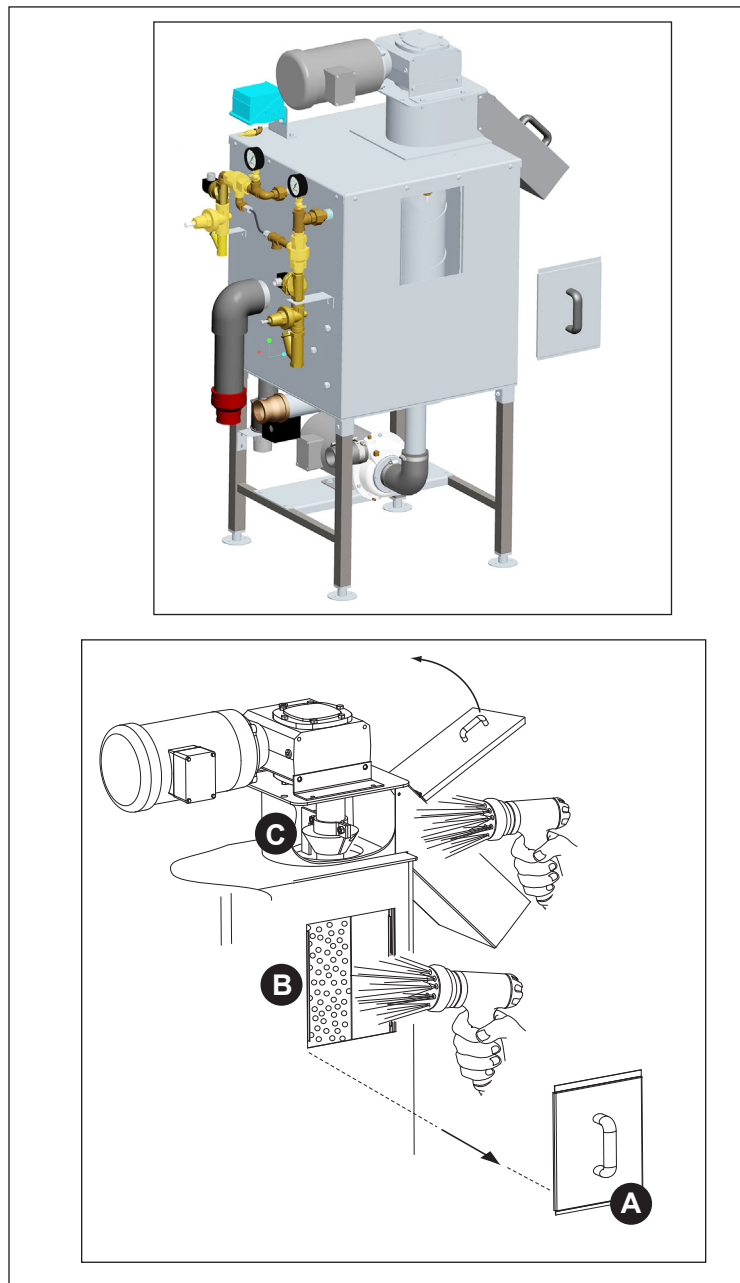

Fig. 18

## Feed Trough Cleaning



**DANGER:**  
THE GRINDER CONTAINS ROTATING CUTTERS.  
DO NOT OPERATE WITHOUT GUARDS IN PLACE.

- Perform a Clean Mode and stop the system.
- Inspect for any metal objects in the trough and remove.
- Wipe the interior of the trough with a soft cloth. Do not use metal scouring pads.
- Open the grinder access door and inspect the grinder teeth for metal objects. Contact a supervisor if metal is observed and disconnect main power to the system.

## Cleaning for Extended Shutdown

- Perform a Clean Mode and stop the system.
- Open the slurry tank drain valve(s) and drain the tank.
- Close the valves.
- Press the green start/stop station button to fill the machine.
- Run the machine for 10 minutes.
- Perform another Clean Mode.
- Cleaning complete.

# Alarms

## DOOR OPEN alarm

- Indicates Waterpress chute or grinder door is open.
- The red start/stop station button is solid.
- Close the door to reset.
- The red pushbutton goes out, the green pushbutton turns green.
- Push the green pushbutton to resume operation.

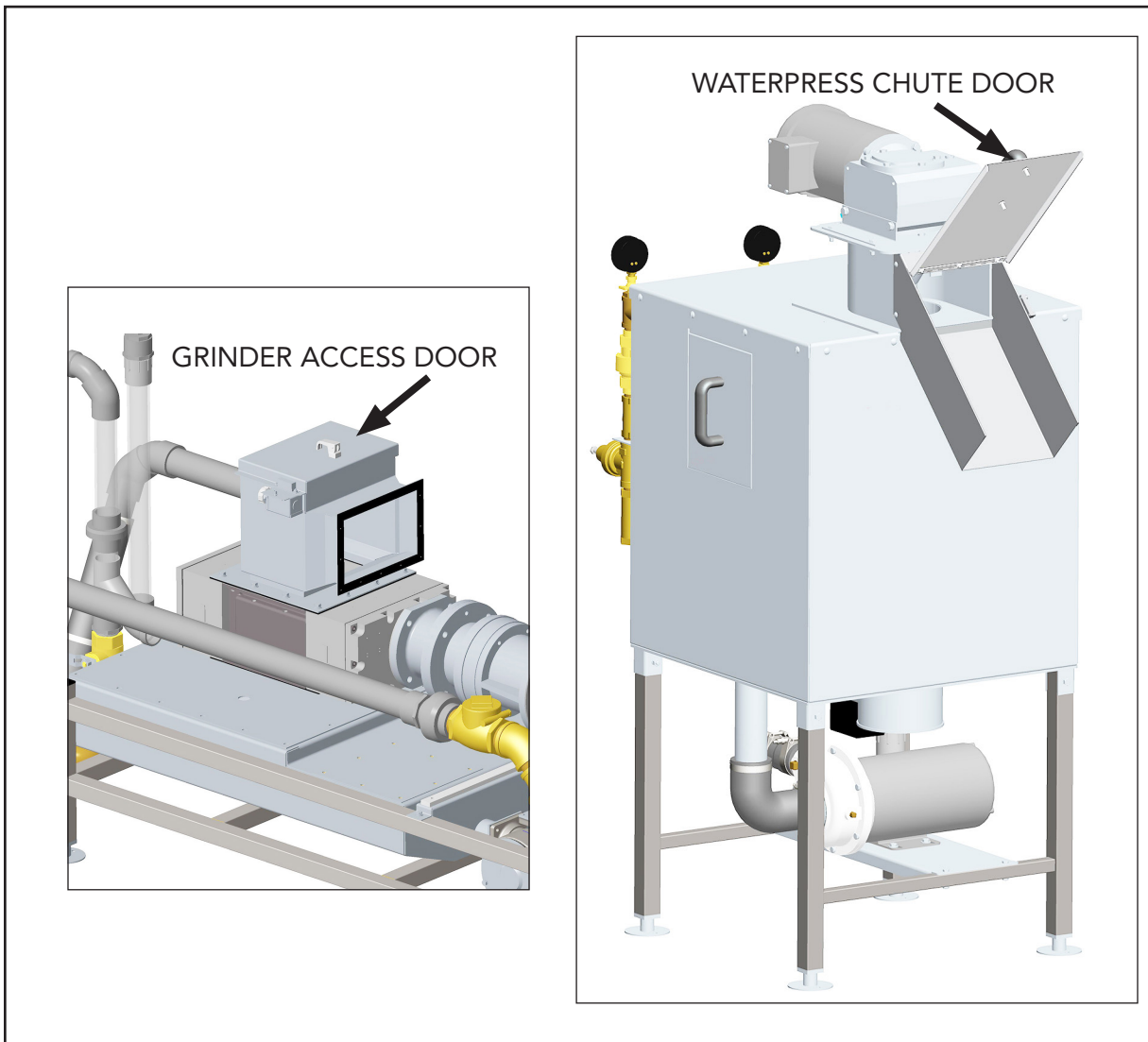
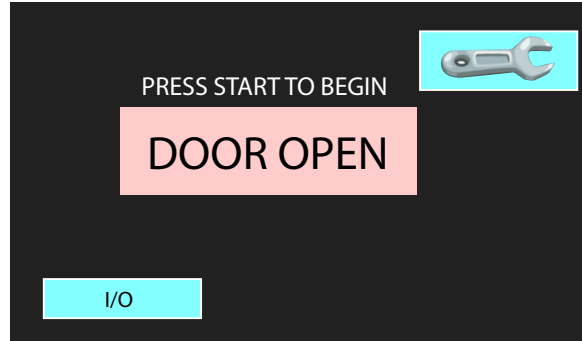
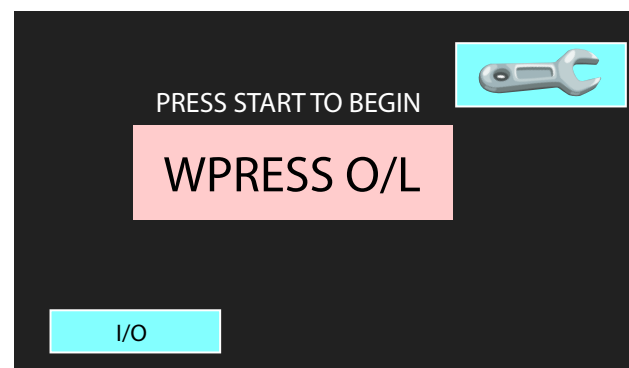
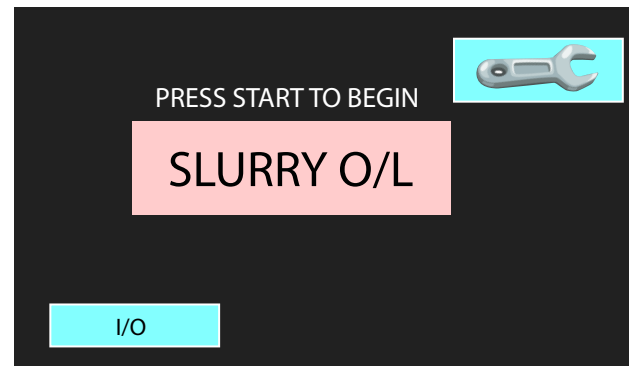
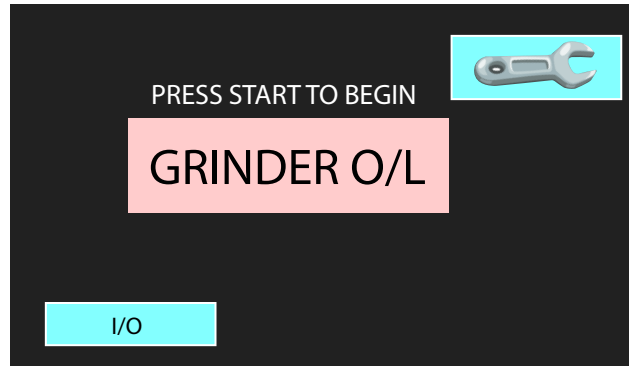

Fig. 17



## MOTOR OVERLOAD alarm

- The O/L appears on the HMI indicating a motor problem.
- Red start/stop station button is solid
- Technician resets the O/L. Red button goes out, green button comes on.
- Press the green start/stop station button to resume operation.



# I/O = Inputs/Outputs

## Inputs

- Press the I/O button to access the input screen.
- Displays component state.
- RED = not operated.  
GREEN = operated



### INPUTS

I/00	PWS	■		I/13	RECFSWL	■
I/01	RECOL	■		I/14	RECFSWU	■
I/02	GRNDOL	■		I/15	RECFSWM	■
I/03	SLUROL	■				
I/04	WPOL	■				
I/05	STOP	■				
I/06	START	■				
I/07	DSS	■				
I/12	E-STOP	■				

OUTPUTS  
BACK

INPUT LEGEND
1/00 - Pressure switch
1/01 - Recirc pump overload
1/02 - Grinder motor overload
1/03 - Slurry pump overload
1/04 - Water press motor overload
1/05 - Start - start/stop station
1/06 - Stop - start/stop station
1/07 - Door safety switch
1/12 - Emergency stop button
1/13 - Recirc tank lower float switch
1/14 - Recirc tank upper float switch
1/15 - Recirc tank middle float switch

## Outputs

- Press the OUTPUTS button on the INPUTS screen to access.

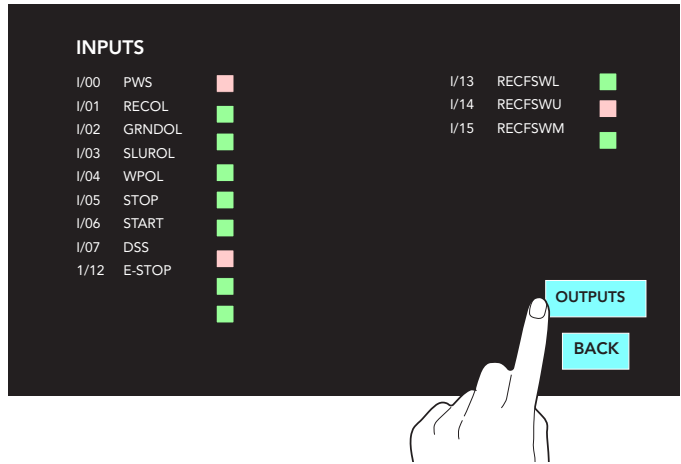

- Displays component state.
- RED = de-energized  
GREEN = energized

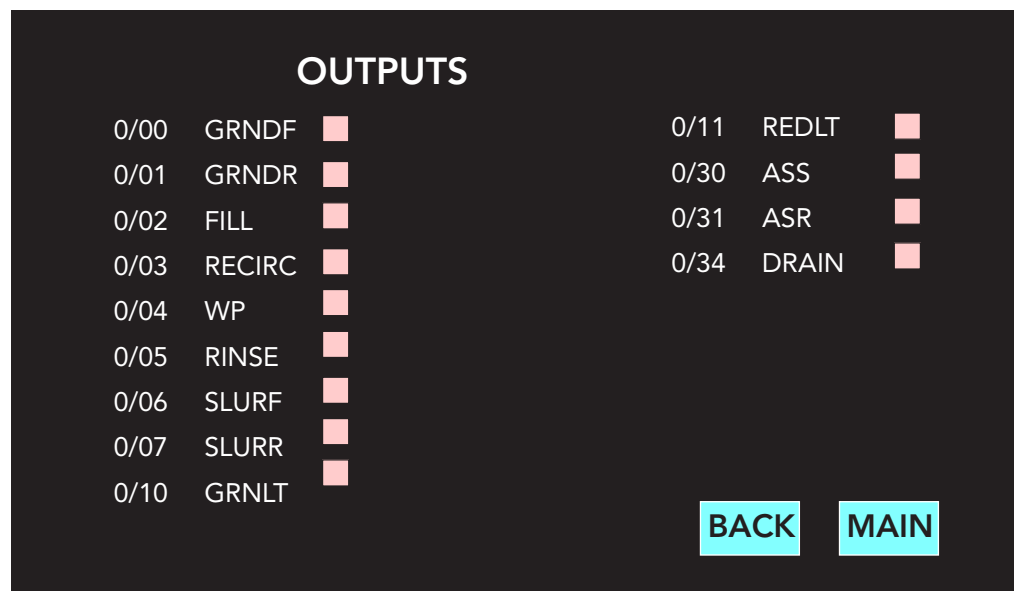

- Press BACK to return to INPUTS
- Press MAIN to return to Home

OUTPUT LEGEND
0/00 - Grinder - forward run
0/01 - Grinder - reverse run
0/02 - Water press fill valve
0/03 - Recirc pump on waterpress
0/04 - Water press motor
0/05 - Water press rinse valve
0/06 - Slurry pump - forward run
0/07 - Slurry pump - reverse run
0/10 - Green light
0/11 - Red light
0/30 - Anti-syphon slurry
0/31 - Anti-syphon recirc
0/34 - Electric drain valve

## Maintenance Mode

- For use by service personnel only.
- Password protected.
- Sets system parameters.
- Press 'WRENCH' symbol to access.



- Enter 4 character alphanumeric password and press ENT.
- MAINTENANCE SCREEN is unlocked.

Password						
USER 2		▲	▼	****		
A	B	C	D	E	F	CAN
G	H	I	J	K	L	
M	N	O	P	Q	R	CLR
S	T	U	V	W	X	
Y	Z	0	1	2	3	ENT
4	5	6	7	8	9	

## MANUAL CONTROL

- Manual Control test runs system components.
- Press 'MANUAL CONTROL'.

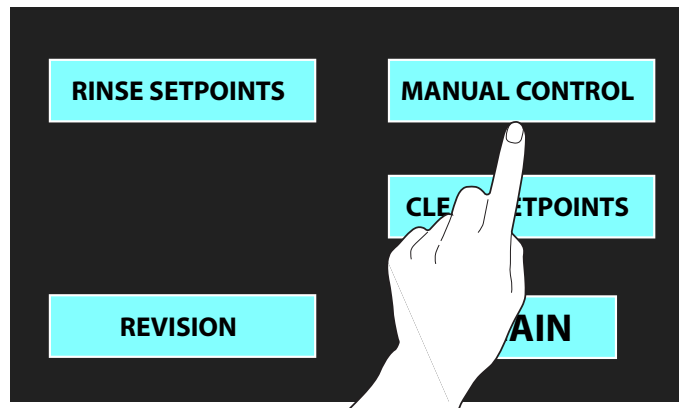

- Press a button to run a component, release to stop.

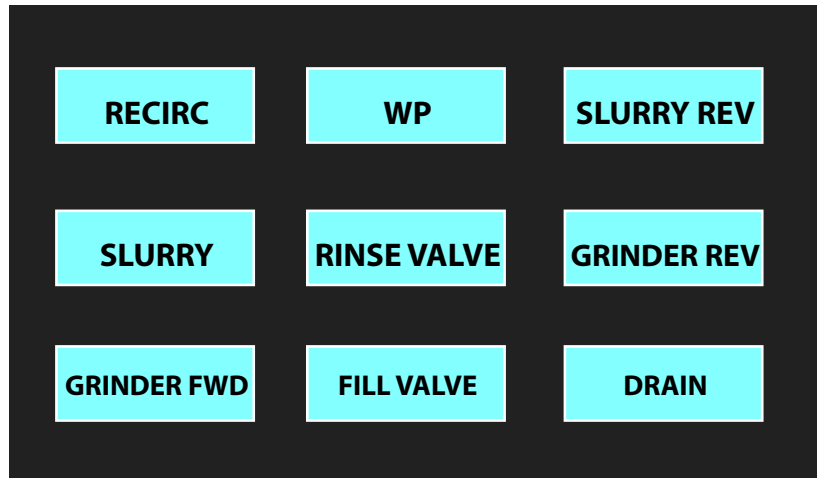

BUTTON	LEGEND
RECIRC	Waterpress recirculation pump
SLURRY	Slurry pump runs forward
GRINDER FWD	Grinder motor runs forward
WP	Waterpress motor
RINSE VALVE	Rinse valve on waterpress runs
FILL VALVE	Fill valve on waterpress runs
SLURRY REV	Slurry pump runs in reverse
GRINDER REV	Grinder motor runs in reverse
DRAIN	Electric drain valve opens

## RINSE SETPOINTS

- Rinse Setpoints adjust the run and off times for the waterpress rinse valve.
- Default settings are 5 and 25

Continued on next page.

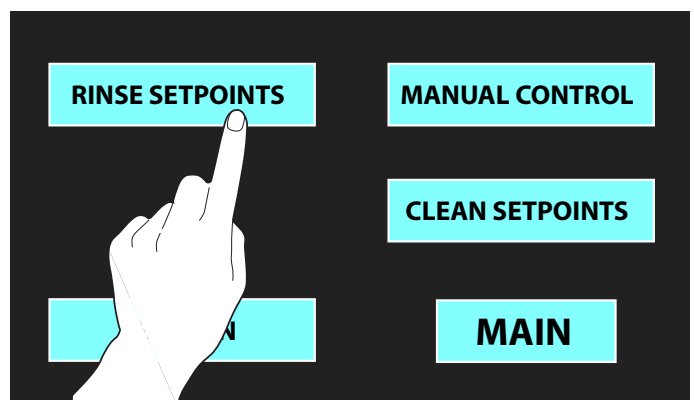



**CAUTION:**  
CONSULT THE FACTORY BEFORE CHANGING A SETPOINT.

## RINSE SETPOINTS (continued)

- TO CHANGE:  
Press 'RINSE SETPOINTS'
- Press a number and the keypad will appear.
- Enter a number and press ENT to change the setpoint.

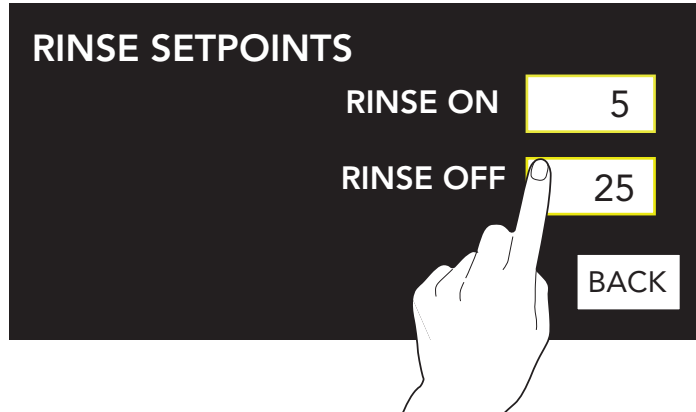

## CLEAN SETPOINT

- Rinse Setpoints adjust the run and off times for the waterpress rinse valve.
- Default setting is 600 seconds.
- TO CHANGE:  
Press 'CLEAN SETPOINTS'
- Press 600 and the keypad will appear.
- Enter a number and press ENT to change the setpoint.

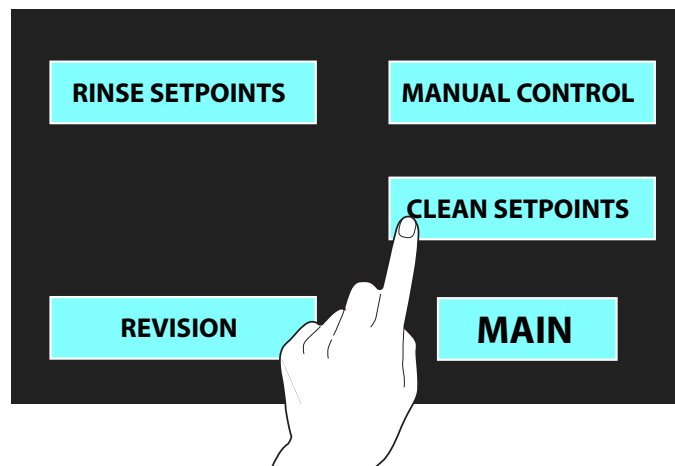

## CLEAN SETPOINTS (continued)

- The default 'CLEAN SETPOINT' is 600 seconds.

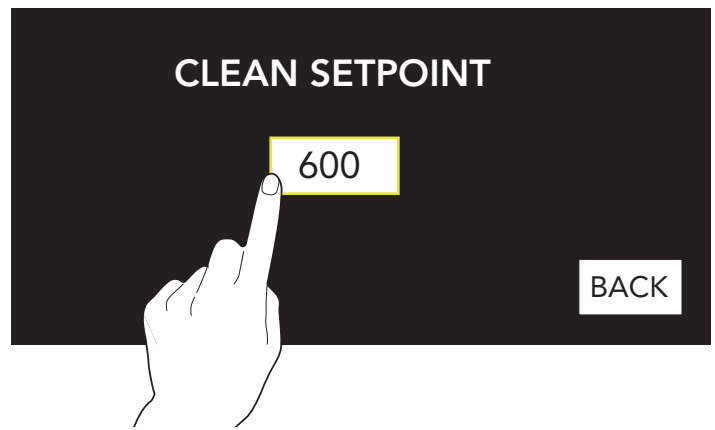

## REVISION

- Each system has a program code recorded under 'REVISION'.
- The code can not be changed without loading another program.

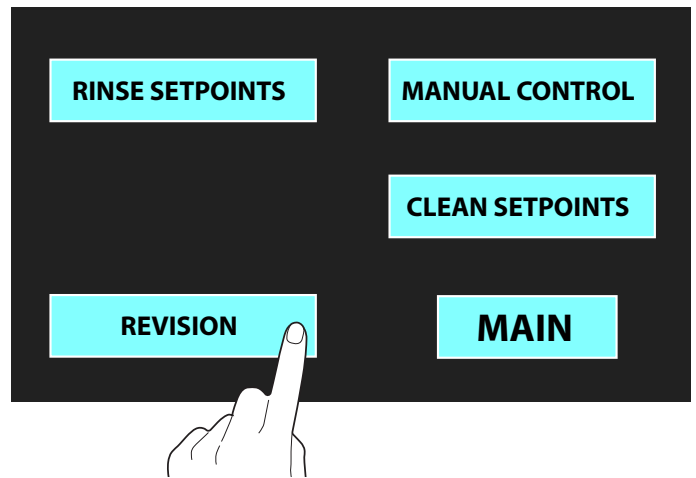

- TO DISPLAY THE CODE:  
Press the 'REVISION' button.  
Press 'MAIN' to return to the home screen.

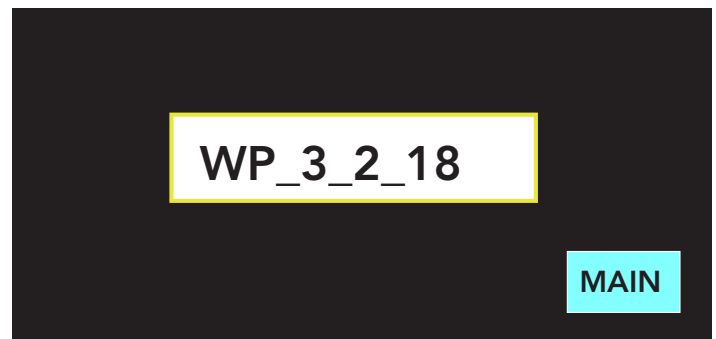

## Troubleshooting Chart

PROBLEM	CAUSE	SOLUTION
Grinder and/or centrifuge is jammed and/or overloaded with waste.	Improper loading of waste and/or the loading prohibited materials.	Follow the waste loading instructions. Contact service agent for repairs.
Will not come on.	Main power OFF. Green start button not pressed.	Turn power on at main breaker. Press start button.
Low or no water in the recirculation tank.	Water supply OFF. Drain open Lower float dirty. Defective lower float. Slurry pump is clogged.	Open supply valve(s). Close drain. Turn off power and clean float. Replace float. Call service agent.
Recirculation tank overflows.	Defective fill valve. Defective or dirty upper float. Recirculation pump clogged or defective.	Repair or replace the valve. Clean or replace float. Contact service agent.
Fills constantly.	Defective upper float. Defective solenoid valve.	Turn off power and clean float. Repair or replace float.
Will not Drain.	Drain valve(s) closed. Building drain clogged.	Open drain valve(s). Clean drain lines.
Green pushbutton flashing.	Is machine filling with status window display "FILLING"?  Does status window display "CLEAN".	Normal - push green button to start.  Normal - push green button when status window displays "READY"
Green pushbutton solid green, not running.	Does status window display "READY"?	Normal condition, push green start button to start.
Red pushbutton is flashing.	Does status window display "E-Stop" Does status window display "Door Open"?	Normal condition - see pg. 10 to reset. Normal condition - close the grinder access door.
Red pushbutton is solid red.	Does status window display "Cfuge OL", "Slurry OL", "Grinder OL", or "Recirc OL"?	Motor overload has tripped - turn power off and call service agent.
Waste pulp is too wet or water is exiting the discharge chute.	Food waste has insufficient mass.  Excess water in the system.	Add small pieces of cardboard to grinder. Contact service agent to adjust.
Odor is detected around machine.	Improper cleaning of machine. Improper cleaning of area around machine.	Clean machine and surrounding area. Refer to cleaning instructions.