

Vortex Wash System

STANDARD FEATURES

- Factory authorized startup
- Type 304 polished stainless steel construction
- 14 gauge stainless tanks and drain boards
- 11" high x 2-1/2" deep back splash
- Twist handle drains
- Stainless steel legs and cross rails
- Stainless steel adjustable bullet feet
- Stainless steel pump and impeller
- Rear discharge
- Removable strainer plates
- One 3 Hp fully enclosed wash pump motor with permanently sealed bearings
- Motor overload protection, manual reset
- Low water protection for wash pump motor
- 3,000 watt wash tank heater
- 1 year parts and labor on pumps and control panel

Photo is for general visual representation only. Please refer to specifications for the latest detailed product information.

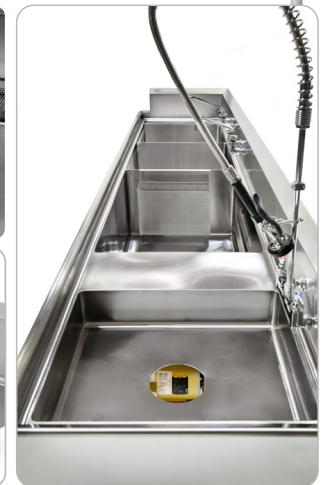

OPTIONS & ACCESSORIES

- 480/60/3 electrical
- Utensil basket
- Folding wash tank cover
- Rinse tank cover
- Sanitize tank cover
- Sheet pan racking system
- Pot and pan overhead shelf with hooks
- Table mounted over shelf
- 1/2" pre-rinse sprayer
- 3/4" fill faucet
- Direction from soiled to clean end (select one)
 - Left to right
 - Right to left

SPECIFIER STATEMENT

Specified unit will be Bi-Line Vortex Wash System. Features (1) 3 Hp wash pump motor, taskmaster control system, stainless steel pump and impeller.

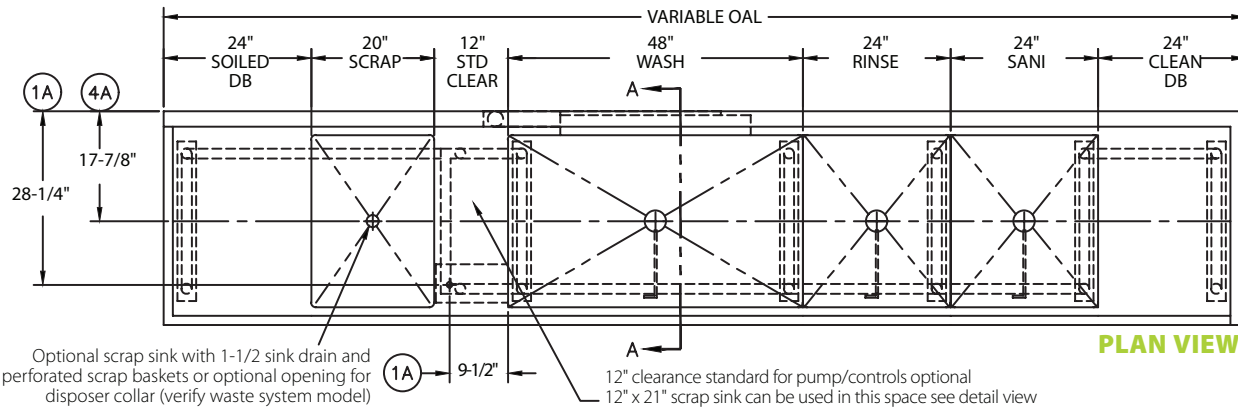

Dimensions shown in inches

(Consult the factory for custom lengths and widths)

Note: Either the soiled drain board or the scrap sink must be at least 24" to accommodate the mechanical components

A
Edge Type

- 1-1/2" Rolled
- 2-1/2" Splash

B
Drain Board
By nominal inch

- 12"
- 18"
- 20"
- 24"
- 36"
- 42"
- 48"
- 54"
- 60"
- w/Disposer Collar

C
Scrap Sink

- 18"
- 20"
- 24"
- Custom**
- w/Scrap Basket

D
Wash Tank

- 36"
- 42"
- 48"
- 60"

Options

- Utensil Basket
- Sheet Pan Racking System

E
Rinse Sink

- Omit
- 20"
- 24"
- 36"

F
Sanitizer Sink

- Omit
- 20"
- 24"
- 36"

G
Drain Board

- Omit
- 12"
- 18"
- 20"
- 24"
- 36"
- 42"
- 48"
- 54"
- 60"

H
Edge Type

- 1-1/2" Rolled
- 2-1/2" Splash

FRONT VIEW

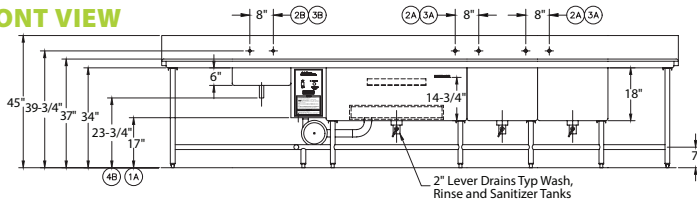

SIDE VIEW

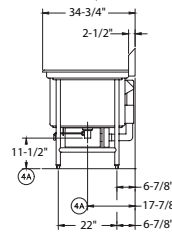

SECTION A-A

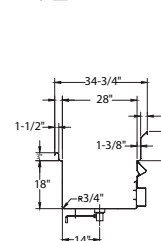

BACK SPLASH

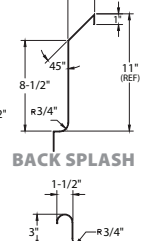

ROLLED EDGE

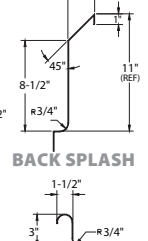

DETAIL VIEWS

VORTEX WASH SYSTEM

Electrical Specifications	Rated Amps	Minimum Supply Circuit Ampacity	Maximum Overcurrent Protective Device
208/60/1	38	50	50
240/60/1	42	60	60
208/60/3	17	25	25
240/60/3	18	25	25
480/60/3	8	15	15

VORTEX WASH SYSTEM - NO HEAT

Electrical Specifications	Rated Amps	Minimum Supply Circuit Ampacity	Maximum Overcurrent Protective Device
208/60/1	11	20	20
240/60/1	10	20	20
208/60/3	8	15	15
240/60/3	8	15	15
480/60/3	4	10	10

SPECIFICATIONS

Motor 1 x 3 Hp
Power Requirements (see charts)
Direction of Operation R-L or L-R

Note: 3HP only available in 3 phase; 2 HP only available in 1 phase
Warning: Plumbing and electrical connection should be made by qualified personnel who will observe all the applicable plumbing, sanitation, and safety codes and the National Electrical Code.

Due to an ongoing value analysis program at Bi-Line, specifications contained in this catalog are subject to change without notice.

BilineConveyors.com

Champion
INTEGRATED SYSTEMS

UTILITIES

- 1 Electrical** (see box)
- 2 Hot Water**
3/4" NPT connection for mixing faucet.
1/2" NPT connection for pre-rinse sprayer.
- 3 Cold Water**
3/4" NPT connection for mixing faucet.
1/2" NPT connection for pre-rinse sprayer.
- 4 Drain**
A. Sink drains, 2" NPT
B. Scrapper drain, 1-1/2" NPT (25-5/8" AFF)

an Ali Group Company



The Spirit of Excellence